

OTO PERK

Perk
diesel spares

REPAIR KITS CATALOGS

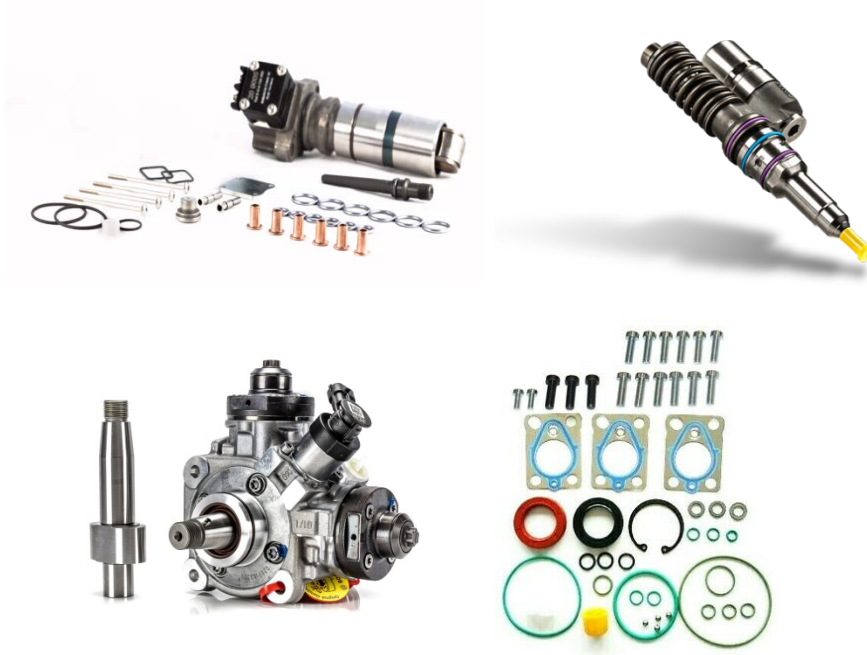

OTO PERK A.S.

Sair Esref Bulvarı No: 27/2 35210 Izmir – TURKIYE

Tel : +90.232.4782990 Fax : 232.4783010

E-Mail : otoperk@eurodiesel.com Web : www.eurodiesel.com

Unit Pump (EUP - PDE) Repair Kits
MB Atego – Axor - Actros

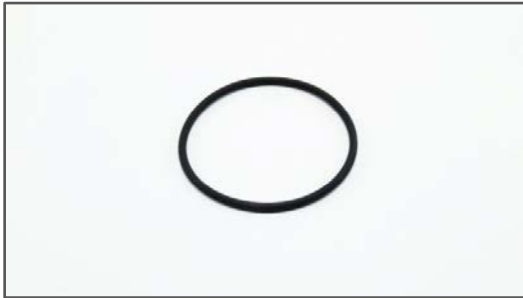

A4-15228 Single Body O'Ring (Black)

Use = MB Actros-Axor / Pump No :0 414 799 005

OEM = F 00H N35 932

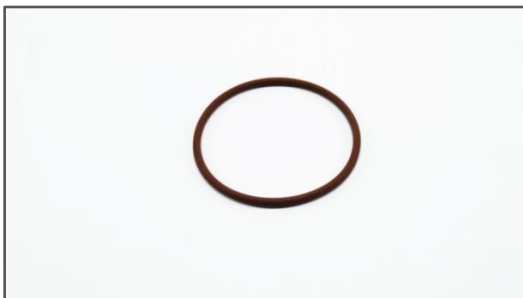

A4-15212 Single Body O'Ring (Brown)

Use = MB Actros-Axor / Pump No :0 414 799 005

OEM = F 00H N35 933



A4-15211 Single Body O'Ring (Green)

Use = MB Atego / Pump No : 0 414 799 008

OEM = F 00H N37 622



A4-15177 Single Body O'Ring (Black)

Use = MB Atego / Pump No : 0 414 799 008

OEM = F 00H N37 621 / F 00H N36 644
F 00H N37 072



A4-10198 Selenoid Plate Gasket

Use = MB Actros – Atego – Axor - Daf

OEM = F 00H N 37 008



Unit Pump (EUP - PDE) Repair Kits MB Atego – Axor - Actros



A1-25105 Repair Kit x 12 O'Rings
Complete O'Ring Kit for Pump Body
Use = MB Actros - Axor
Pump No :0 414 799 005

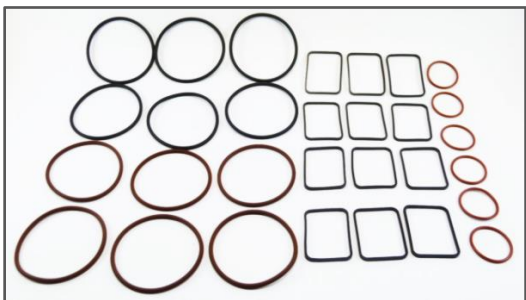

A1-25105X Repair Kit x 30 O'Rings
Full Set O'Ring Kit for Pump Body + Selenoid
Use = MB Actros – Axor
Pump No :0 414 799 005



A1-25104 Repair Kit x 12 O'Rings
Complete O'Ring Kit for Pump Body
Use = MB Atego
Pump No :0 414 799 008

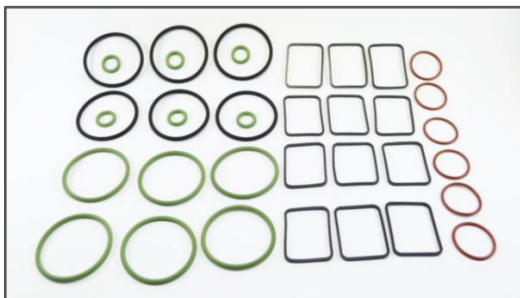

A1-25104X Repair Kit x 36 O'Rings
Full Set O'Ring Kit for Pump Body + Selenoid
Use = MB Atego
Pump No :0 414 799 008

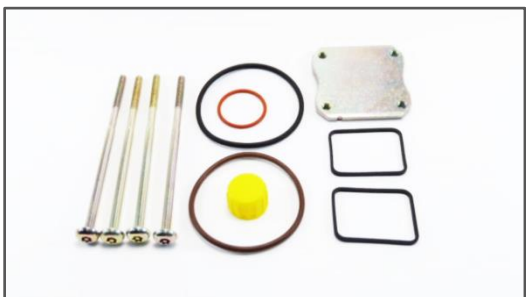

A1-23195 Repair Kit PDE
Use = MB Actros - Axor
OEM =f 00H N37 069

Unit Pump (EUP - PDE) Repair Kits
MB Atego – Axor - Actros



A1-23195/1 Repair Kit PDE w/o plate
Use = MB Actros - Axor
OEM = F00H N37 069 similar



A1-23195/2 Repair Kit PDE + Inj. washer
Use = MB Actros - Axor
OEM = F 00H N37 069 similar

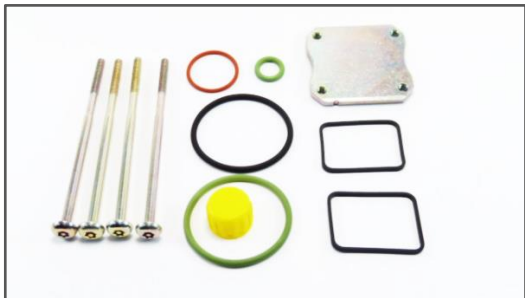

A1-23120/1 Repair Kit PDE
Use = MB Atego
OEM = F 00H N37 070



A1-23120 Repair Kit PDE w/o plate
Use = MB Atego
OEM = F 00H N37 070 similar

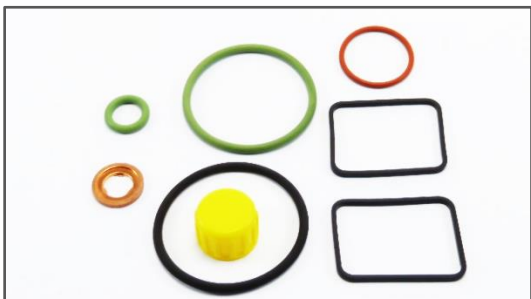

A1-23120/2 Repair Kit PDE + Inj. Washer
Use = MB Atego
OEM = F 00H N37 070 similar



Unit Pump (EUP - PDE) Repair Kits MB Atego – Axor - Actros



A1-23237 Solenoid Screw PDE (5 Star)

Use = MB Atego –Actros-Axor / Man / Daf

OEM =



A1-23424 Solenoid Plate Fixing Ccrew

Use = MB Atego –Actros-Axor / Man / Daf

OEM = F 00H N35 725



P2-11002- Injector Base Washer

Use = MB Atego –Actros-Axor

OEM = 2 430 105 049



P2-09091 Injector Base Heat Shield

Use = MB Atego

OEM = F 00Z W00 001



A1-23439 Valve

Use = MB Atego –Actros-Axor

6,995mm - 7,000mm - 7,005mm

7,010mm - 7,015mm - 7,020mm

7,025mm - 7,030mm - 7,035mm

7,040mm



Unit Pump (EUP - PDE) Repair Kits
MB Atego – Axor - Actros



A1-23268 Plate
Use = MB Atego – Axor – Actros
OEM =

Unit Pump (EUP - PDE) Repair Kits
DAF Euro III



A4-20103 Single O’Ring DAF Euro 3
Use = DAF Euro 3 PDE
OEM =



A1-23403 Body O’Ring Kit Euro 3
Use = DAF Euro 3 / PLD1B110/520
OEM = F 00V X99 892



A4-20100 Repair Kit x 18 O’Rings
Full Set O’Ring Kit for Pump Body
Use = DAF Euro 3
Pump No



Unit Pump (EUP - PDE) Repair Kits
DAF Euro III _ Euro 5

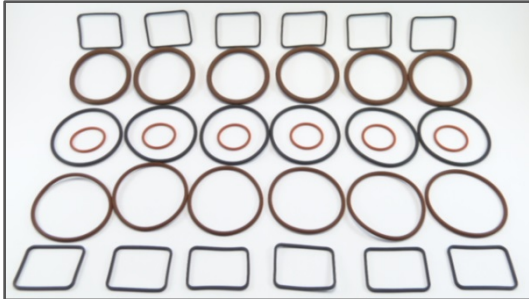

A4-20100X Repair Kit DAF **Euro III**
x 36 O'Rings
Full Set O'Ring Kit for Pump Body + Selenoid

Use = DAF Euro 3



A1-23717 Repair Kit DAF **Euro 5**

OEM Ref's Used = 7207-0100 / 72000027
7200-0070 / 7200-0071 / 7208-0247

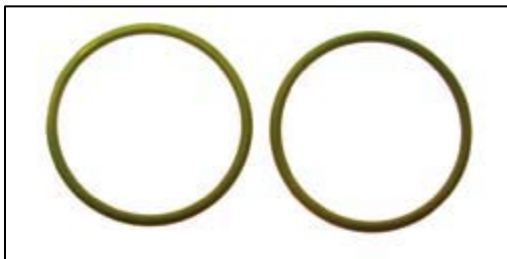

A1-23446 Repair Kit Volvo – KHD

PLD1A100/440
PLD1A90/440
OEM : F 000 41P 053

Pumps Used : 0 414 750 002 – 003 – 004



A1-23447 Repair Kit Volvo – KHD

PLD1A100/440
PLD1A90/440
OEM : F 000 41P 052

Pumps Used : 0 414 750 002 – 003 – 004

Unit Pump (EUP - PDE) Repair Kits
Various

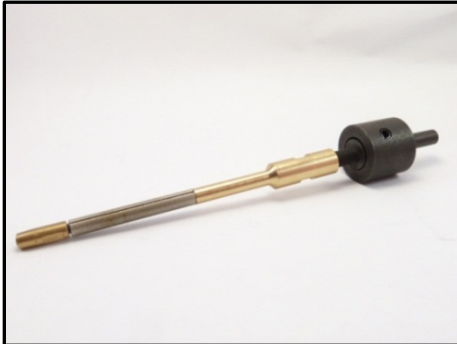

A1-23365 Reamer / Valve Hole

Unit pump valve hole reamer
With drill use
Long life durable material



A1-23430 Reamer / Valve Seat

Unit pump valve seat reamer
With hand Use
Long life durable material



A1-23391 Plug

Various sizes available
14.56 mm / 15.10 mm



A1-23393 Plug

Various sizes available
9.40 mm / 9.84 mm

Unit Injector (EUI-PDE-UIS) Repair Kits
VOLVO 2 Pin – 4 Pin Injectors

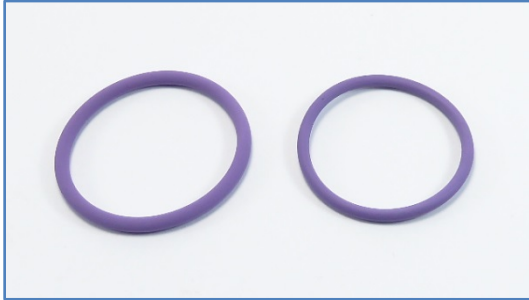

A1-23162 Repair Kit Volvo EUI

Use = Volvo 2 pin – 4 Pin Delphi Injectors

OEM = 7200-0016 + 7200-0017

OEM = F 00V X99 992 (Bosch 0 414 702***)



A1-23144 Repair Kit Volvo EUI

Use = Volvo Delphi EUI / Yellow side Actuator

7200-0016 + 7200-0017 + 7200-0014 + 7200-0015

OEM = Volvo 276948



PRK135-486 Valve Kit Actuator Delphi EUI

Use = Volvo FH Actuator

OEM = 7135-486 (Valve Used Inside)



PRK206-0379A

Actuator Volvo 2 Pin Injectors
Without Electrical Coil



PRK206-0379

Actuator Volvo 2 Pin Injectors
With Electrical Coil

Unit Injector (EUI-PDE-UIS) Repair Kits
VOLVO 2 Pin – 4 Pin Injectors

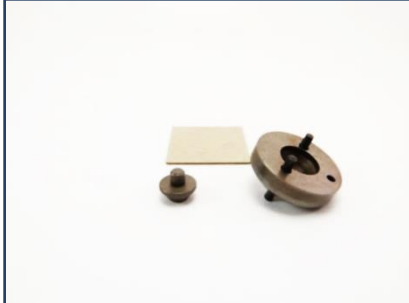

P2-03059 Inj. Sapcer Kit Type Delphi EUI

Use = Volvo FH
Using Actuator 7135-486

OEM = **7135-487**



P2-02039 Inj. Pressure Spring EUI

Use = Volvo / Delphi 4 pin Injectors

OEM = **7207-0070**

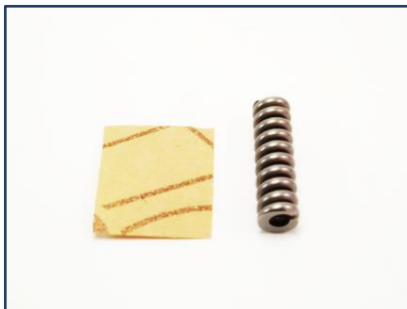

P2-02032 Inj. Pressure Spring EUI

Use = Volvo / Delphi 2 pin Injectors

OEM = **7169-539**



A2-23294 Repair Kit Volvo FH

Use = Volvo FH

OEM = **7135-488**



A2-23476 Repair Kit Volvo FH

Use = Volvo FH Actuator

OEM = **7135-476**

Unit Injector (EUI-PDE-UIS) Repair Kits
VOLVO 2 Pin – 4 Pin Injectors

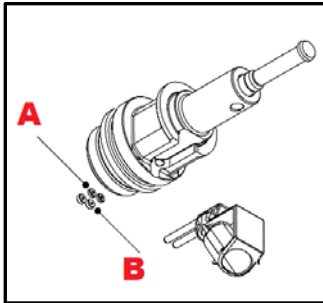

A4-15579 Backing O'Ring
Use = Volvo **2 Pin – 4 Pin** Injectors

Oem No : **7204 -0375**

Figure : " A "



ED4069 Electrical Connector
Use = Volvo **4 Pin** Injectors

Including 20 cm Cable (mounted)



ED4070 Electrical Connector
Use = Volvo **2 Pin** Injectors

Including 20 cm Cable (mounted)

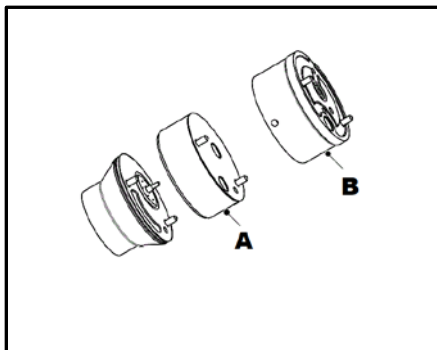

PRK135-588 Actuator Upper Body Kit

Oem No : **7135-588**

Use = Volvo **4 Pin** Injectors

Kit Contains Figure "A" + "B"



A4-15299 O'Ring Set

Oem No : **7200-0031**

Use = Volvo **2 Pin** Injectors

John Deere Unit Injector BEBE4B13001

Unit Injector (EUI-PDE-UIS) Repair Kits
DAF Euro5 - Smart

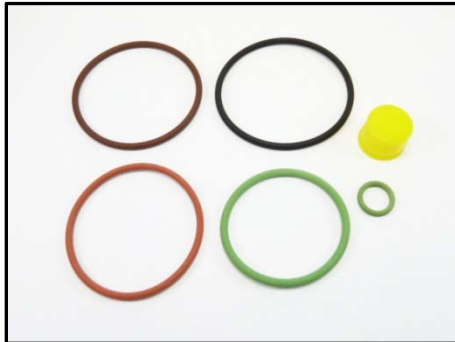

A1-23717 Repair Kit DAF Euro 5

Use = Injector Daf Euro 5 Delphi Unit Pump

OEM Ref's Included = 7207-0100 / 7200-0027

7200-0070 / 7200-0071 / 7208-0247

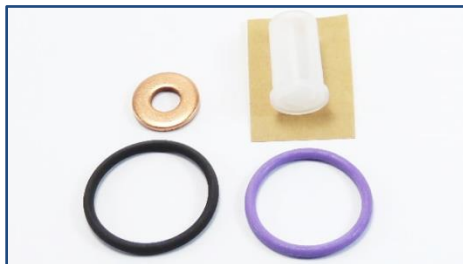

A1-23716 Repair Kit DAF Smart Euro 5

Use = Injector Daf Euro 5 Delphi Smart Injector

OEM Ref's Included = 7200-0118 / 7200-0119

Injectors's Used :

BEBJ1A00001

BEBJ1A00101

BEBJ1A00201

BEBJ1A00202

BEBJ1B00001



A1-23716A Repair Kit DAF Smart Euro5
Euro6

Use = Injector Daf Euro 5 Delphi Smart Injector

OEM O'ring Ref's Included :

7200-0118 + 7200-0119 + 7200-0271

Injectors Used : BEBJ1A00001 / BEBJ1A00101

BEBJ1A00201 / BEBJ1A00202

BEBJ1B00001

BEBJ1A05001 / BEBJ1A05002

Unit Injector (EUI-PDE-UIS) Repair Kits
Type Bosch



A1-23367 Valve

Unit injector Valve

Dia's . 6.995 to 7.040 mm



A1-23203 Repair Kit EUI Iveco

Use = Iveco Stralis, Eurotracker, Eurotech

Unit Inj. Ref's = 0 414 700 002/ 003

OEM = **F 00V X99 996** Iveco ref : 500350189



A1-23206 Repair Kit EUI Scania

Use = Scania 1398810 - 1422564

Unit Inj. Ref's = 0 414 701 005 / 007 / 008

OEM = **F 00V X99 999**



A1-23202 Repair Kit EUI Scania

Use = Scania 1440576 – New Holland 500379769

Unit Inj. Ref's = 0 414 701 006 / 013

OEM = **F 00V X99 995**

Unit Injector (EUI-PDE-UIS) Repair Kits
Type Bosch



A1-23205 Repair Kit EUI Scania

Use = Scania 1731209

OEM = **F 00H N37 928**



A1-23471 Repair Kit Scania G Series

Use = Scania G series trucks

OEM = **F 00H N37 927 + 928 + F 00V X99 999**



A1-23210 Repair Kit Scania EUI

Use = Injector Bosch 0 414 701***

OEM = **F 00H N37 926 + N37 927 + F 00V X99 999**



A2-23282 Repair Kit Volvo FH

Use = Volvo FH Body
0 414 701 004 / 0 414 701 055
0 414 702 002 / 0 414 702 017

OEM = **F 00V X99 998**

Unit Injector (EUI-PDE-UIS) Repair Kits Type Bosch



A2-23431 Repair Kit EUI

Use = Iveco Stralis Euro 5 = 0 414 703 008 - 009
Iveco EuroTracker = 0 414 703 004

OEM = **F 00H 450 001**



A2-24032 Repair Kit EUI

Use = Iveco Stralis 430-480-530 = 0 414 701 013
Iveco EuroCargo 280-330-350-400 = 0414701 006

OEM = F 00H N37 928 + F 00V X99 998



A2-23217 Repair Kit EUI / Universal

Use = Volvo B12 – FH 12
Use = Iveco Stralis, EuroCargo / Scania

OEM = F 00H N37 928 + F 00V X99 998 +
F 00V X99 996
REF Volvo : 276948



A2-23213 Repair Kit EUI / Universal

Use = Iveco Stralis, EuroCargo , EuroTech

OEM = F 00H N37 928 + F 00V X99 996

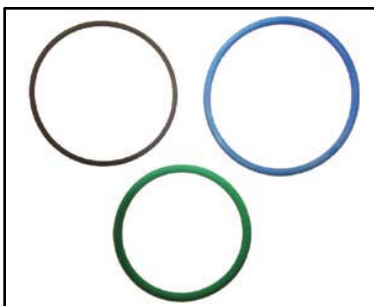

A2-23642 Repair Kit EUI

PDE 100S4001/2/4/6

Use = 0 414 703 ***
002/003/005/007

Unit Injector (EUI-PDE-UIS) Repair Kits
Type Bosch



A1-23218 Spring & Pin Kit
Bosch PDE 90 / 100

Oem No : **F 00H N37 926**



A1-23433 Spring & Pin Kit
Bosch PDE 100

Use = 0414703***

Oem No : **F 00H 4S0 008**



P2-03046 Inj. Intermediate Plate EUI

Use = Scania / 1774409

0 414 700 002 ... / 0 414 701 004

OEM = **F 018 B06 804 / F 00Z Z20 003**

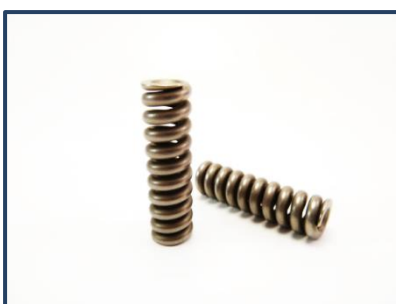

P2-02027 Inj. Pressure Spring Bosch EUI

Use = Iveco / 0 414 700 008 & Similar Injectors

OEM = **2 434 614 040**



P2-23028/1 Injector Spacer PDE90 / 100

Use = 0414701** / 702** / 703 ***

Oem No's : **F 00Z 220 003**

F 00H N35 703

Dia : 17.8 x 7 mm

Unit Injector (EUI-PDE-UIS) Repair Kits
Type Bosch



A1-23420 Piston & Sphere Set

Use : 0414701*** Bosch Injectors

Oem No : F 00V X99 886



A1-23419 Piston

Use : IVECO Stralis - Trakker

Oem No : F 00H N36 046



A1-23422 Piston & Sphere

Use : 0414701005 /***

Oem No : F 00V X99 994



A1-23421 Piston & Sphere

Volvo

Use : 0414702*** / Bosch Unit Injectors

Oem No : F 00V X99 887



A1-23391 Plug PDE 90 / 100

Thickness : 14,56 – 15,10 mm

Available as sets with various Dia's

Unit Injector (EUI-PDE-UIS) Repair Kits
Type Bosch



A1-23430 Reamer for Valve Seat

Unit pump valve seat reamer
With hand Use
Longlife durable material

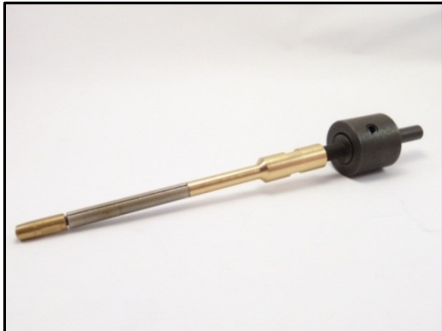

A1-23365 Reamer for Valve Hole

Unit pump valve holereamer
With drill use
Longlife durable material



A1-23425 Plate

Various sizes
3.80 mm to 4.00 mm
+02 mm increase



PRK26124 R/K Cummins N14 - M11

Use : Cummins N14 – M11 Injectors

Other : M-26124



PRK3060001A R/K Cummins N14 - M11

Use : Cummins N14 – M11 Injectors

Other : 3060001 Similar



PRK3060001 Complete Repair Kit Celect

Use : Cummins Celect N14 – M11 – L10 Injectors

OEM : 3060001 - 1211594



A1-23916 Pressure Spring N14 - M11

Use : Cummins N14 – M11 – L10 Injectors

Other : 3066738



PRK9898 Wiring Harness Cummins Without End Socket (Economical Version)

Use : Cummins N14 – M11 – L10 Injectors

Other : Similar 3803682



PRK3803682 Wiring Harness Cummins Complete

Use : Cummins N14 – M11 – L10 Injectors

Other : 3066738



PRK3411711 Plunger Male Ceramic

Use : Cummins N14 – M11 – L10 Injectors

Other : 3411711



PRK3010242 Cummins N14 Pump R/K

Use : Cummins Fuel Pump Gasket Kit for NT-903-KT 3010242, 3004122, AR45246; PAI 131504



Cummins Injector Tips / Nozzles

Catalog is at the end of file



PRK3095356 Splined Drive Shaft

Use : Cummins Celect



PRK3034407 Poppet Valve

Use : Cummins N14 M11

Other : 7991123



Cummins ISX – QSX Injector Repair Kits



A1-23968 Body O'Ring Kit

Use :Cummins ISX – QSX



A1-23968A Body O'Ring Kit Inc. Base washer

Use :Cummins ISX – QSX / For 1 Cyl

Oem : 1441237



A1-23968S Body O'Ring Kit Inc. Base washer

Use :Cummins ISX – QSX / For 6 Cylinders



A1-23968C Complete Repair Kits

Including O-rings + Filters + O,I Seal

Use :Cummins ISX – QSX

Oem No : 5025063



EDB171 Oil Seal

Use :Cummins ISX – QSX

Oem No : 5025063

Cummins ISX – QSX Injector Repair Kits



ED4009692 **Inj. Body Filter Upper**
Use : Cummins ISX – QSX
Oem No : 4009692



ED3087316 **Inj. Body Filter Lower**
Use : Cummins ISX – QSX
Oem No : 3087316



A1-23967 **Injector Spring ISX-QSX**
Use : Cummins ISX – QSX
Scania R series



A1-23967A **Injector Spring ISX-QSX**
Use : Cummins ISX – QSX
Scania R series

Cummins ISX - QSX Injector Nozzles



Perk Ref	Nozzle No	Injector Used	Other	Engine Type	Holes
PRK-QSX4928264	4928264	4928260		Cummins ISX	6
PRK-QSX4088652	4088652	4062569		Cummins QSX	8
PRK-QSX4088648	4088648	4062568		Cummins ISX - QSX	8
PRK-QSX4088660	4088660	4088327		Cummins ISX	9
PRK-QSX4088662	4088662	4088665		Cummins ISX 475	9
PRK-QSX4902824	4902824	1846348		Cummins QSX	8
PRK-QSX4076965	4076965	4954646	1764365	ISX Small Tip	9
PRK-QSX4903455	4903455	4521978	1499257	Cummins ISX	8
PRK-QSX4954886	4954886	4954888		Cummins ISX	9
PRK-QSX4954432	4954432	4954434		Cummins ISX	7
PRK-QSX3348357	3348357			Cummins ISX	8
PRK-QSX3331254	3331254	1521977		Cummins - Scania ISX	8



PRK-XPI01 Injector Plate Kit XPI

Use : Cummins HPI

Cummins XPI Series



PRK-XPI2897551A Nozzle for INJ. XPI
Without pin

Use : Cummins XPI

Injectors Used : 2872405



PRK-XPISOL XPI Injector Solenoid

Use : Cummins XPI

Injectors Used : Universal

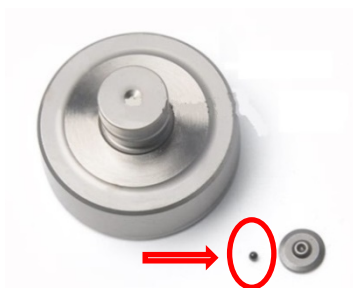

PRK-XPI01B Sphere for XPI Plate

Use : Cummins XPI

Small Sphere for the valve Seat



A1-23490 Injector Repair Kit
Kit Including Heat Shield

Use : Ford Powerstroke 7.3 - Navistar



A1-23580 Injector Repair Kit
Complete Kit

Use : Ford Powerstroke 7.3 - Navistar



A1-23578 Injector Repair Kit
Complte Body + Internal kit

Use : Ford Powerstroke 6.0 / 4.5 L / G2.8



A1-23577 Injector Repair Kit
Internal repair Kit

Use : Ford Powerstroke 6.0 / 4.5 L / G2.8



A1-23576 Injector Repair Kit
External O'ring Kit

Use : Ford Powerstroke 6.0 / 4.5 L / G2.8



Navistar - Ford Powerstroke

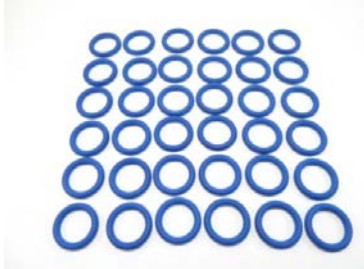

A1-15309 **Injector Repair Kit**
O'Ring Set (36 pcs)

Use : Ford Powerstroke 7.3
Navistar



PRKPM507 **Injector Tip (Nozzle)**
Other No : 41507/31

Use : Navistar 466E
Injectors Used : 1824740C1 / EX63809BC

**For other Injector tips you can view our
Heavy Duty Nozzle catalog for**



Ford Powerstroke



PRKPWR-0001 **Harness Kit Ford**

FORD Powerstroke 6.0L / 4.5L

AP60800, 1843481C94, 1846692C92
1844751C2, 1845150C92, 1846692C92,
1877748C1, 1878284C91, 1878285C91,
1879998C91



A1-23594 Injector Repair Kit

Use : Detroit Diesel 50/60 Series



A1-23595 Injector Repair Kit
External Body + Solenoid

Use : Detroit Diesel 50/60 Series



P2-03076 Injector Spacer

Use : Detroit Diesel 50/60 Series
Suitable Cummins N14 / Celect

REF.NOZZLE	CUMMINS CELECT N14 - M11 - L10	ENGINES USED
	OTHER NO	
PRK3411404	3411758; 3411401	M11; M11-E
PRK3095734	3411755	M11;
PRK3095043	3095040; 3411753; 3045102	M11-330; M11-330E
PRK3609925	3095731; 3411756; 3609922; 3166395;	N14;-480CE; 525; 525E; 526CE; M11-ISM-335
PRK3095729	3411754; 3087772	M11; MTA11; M11-350
PRK3609861	3411759; 3083846; 3087560; 3087733	N14-330P; N14
PRK3411694	3409975; 3411691; 3411766; 3411762	N14; NTA14-E
PRK3085492	3087557; 3411752; 3084589; 3087772; 3411754	M-11-250E; 280E; 310; 330;330C; 335E;M11-370
PRK3076071	3070739; 3652541; 3081314; 3073995; 3081315; 3652542	N14; N14-310E; N14-460E; 430E; N14-330E; N14-410E; N14-370E; N14-350E
PRK3411690	3087807; 3411381; 3411761; 3411765	N14-310E; N14-310; N14
PRK3609852	3087807; 3411381; 3411761; 3411765	N14-310E; N14-310; N14
PRK3409978	3411762; 3409975; 3411691; 3411766	N14; NTA14-E
PRK3609855	3083848; 3087734; 3411760; 3087558; 3087737;	NTA14-E; N14-435E; N14-500E; N14-350; N14;
PRK3079963	3652540; 3081318; 3073996	L10
PRK3411388	3411385; 3411767; 3087558; 2411767	NTA14-E; N14
PRK3088175	3088178; 3411764	N14-480CE; 525; 525C; 525E; 526CE; N14-525;
PRK3087791	3411763; 3087788; 3087556; 3095086	N14-500E; N14-525E; N14
PRK3076062	3652516; 3076029; 3071534;	L10; L10370E
PRK4908174	4928171	
PRK4061854		Celect N14
PRK4026225	4026222; 3609922; 3411756	M11-335



REF.NOZZLE	CUMMINS / DETROIT DIESEL SERIES 60	ENGINES USED
	OTHER NO	
PRK4902924	4902921	Cummins Celect M11
PRK4902928	4902928	
PRKP6051-A1	4991751-A1	Detroit Diesel S60 11.1L Detroit Diesel S 60 Serie
PRKP6051-A1		
PRKP6051-A2	4991751-A2	Detroit Diesel S 60 Serie Detroit Diesel S 60 Serie
PRKP6052-B1	4991752-B1	Detroit Diesel S 60 Serie Detroit Diesel S 60 Serie
PRKP6052-B2	4991752-B2	Detroit Diesel S 60 Serie Detroit Diesel S 60 Serie
PRKP6052-B3	4991752-B3	Detroit Diesel S50/60 8.5L
PRKP6052-B3		
PRKP6052-B4	4991752-B4	Detroit Diesel S 60 Serie
PRKP6052-B4		
PRKP6052-B4		
PRKP6052-B5	4991752-B5	Detroit Diesel S50/60 12.7L
PRKP6052-B5		
PRKP6052-B6	4991752-B6	Detroit Diesel S 50/60 Serie
PRKP6053-C1	4991753-C1	Detroit Diesel S 60 Serie
PRKP6053-C1		
PRKP6053-C1		
PRKP6053-C2	4991753-C2	Detroit Diesel S60 11.1L
PRKP6053-C2		
PRKP6053-C3	4991753-C3	Detroit Diesel S60 11.1L & 12
PRKP6054-D1	4991754-D1	Detroit Diesel S 60 Serie
PRKP6054-D2	4991754-D2	Detroit Diesel S 60 Serie
PRKP6054-D2		
PRKP6054-D2		
PRKP6054-D3	4991754-D3	Detroit Diesel S 60 Serie
PRKP6054-D3		
PRKP6054-D4	4991754-D4	Detroit Diesel S60 12.7L
PRKP6054-D5	4991754-D5	Detroit Diesel S60 12.7L



REF.NOZZLE	DETROIT DIESEL SERIES 60		ENGINES USED
	OTHER NO		
PRKG6438	5226438	9-6	Detroit Diesel 92, N, LS, 9 6
PRKG6272	5226272	9-,0068-165A	Detroit Diesel 92 series
PRKG9026	5229026	6-,055-165A	Detroit Diesel N55 - N60
PRKG9030	5229030	8-,0055-165A	Detroit Diesel N65
PRKG9034	5229034	6-,006-165A	Detroit Diesel N45 & N50
PRKG9184	5229184	7-,007-165A	Detroit Diesel F70...105
PRKG9192	5229192	7-,006-165A	Detroit Diesel 53 M60 - 7N65 - 5A72
PRKG9184	5229184	7-,007-165A	Detroit Diesel 9215, 9280, 9285
PRKG9256	5229256	7-,006-165A	Detroit Diesel M95 N80,90
PRKG9516	5229516	7-,0075-165A	Detroit Diesel 7125, 9210
PRKG9636	5229636	9-,0058-165A	Detroit Diesel 7A65,70,75 7C70,75
PRKG9806	5229806	8-,0068-165A	Detroit Diesel FB/FC70,75,80,90
REF.NOZZLE	DETROIT DIESEL SERIES 53 - 71, S		ENGINES USED
	OTHER NO		
PRKG8101	5228101		DETROIT DIESEL SERIES 53/71, S
PRKG8126	5228126		DETROIT DIESEL SERIES 53/71, S
PRKG8304	5228304		DETROIT DIESEL SERIES 53/71, S
PRKG8306	5228306		DETROIT DIESEL SERIES 53/71, S
PRKG8378	5228378		DETROIT DIESEL SERIES 53/71, S
PRKG8495	5228495		DETROIT DIESEL SERIES 53/71, S
PRKG8552	5228552		DETROIT DIESEL SERIES 53/71, S
PRKG8656	5228656		DETROIT DIESEL SERIES 53/71, S
PRKG8658	5228658		DETROIT DIESEL SERIES 53/71, S
PRKG8661	5228661		DETROIT DIESEL SERIES 53, 71, 92
PRKG8668	5228668		DETROIT DIESEL SERIES 53, 71, 92
PRKG8682	5228682		DETROIT DIESEL SERIES 53, 71, 92
PRKG8684	5228684		DETROIT DIESEL SERIES 53, 71, 92
PRKG8691	5228691		DETROIT DIESEL SERIES 53, 71, 92
PRKG8749	5228749		DETROIT DIESEL SERIES 53, 71, 92



REF.NOZZLE	DETROIT DIESEL SERIES S53 - 71 , S	ENGINES USED
	OTHER NO	
PRKG8804	P&B 5228804	Detroit Diesel 53, 71, 92
PRKG8878	5228878	Detroit Diesel 53, 71, 92
PRKG8928	5228928	Detroit Diesel 53, 71, 92
PRKG9181	5229181	Detroit Diesel 53, 71, 92
PRKG9188	5229188	Detroit Diesel 53, 71, 92
PRKG9268	5229268	Detroit Diesel 53, 71, 92
PRKG9278	5229278	Detroit Diesel 53, 71, 92
PRKG9282	5229282	Detroit Diesel 53, 71, 92
PRKG9292	5229292	Detroit Diesel 53, 71, 92
PRKG9298	5229298	Detroit Diesel 53, 71, 92
PRKG9342	5229342	Detroit Diesel 53, 71, 92
PRKG9346	5229346	Detroit Diesel 53, 71, 92
PRKG9354	5229354	Detroit Diesel 53, 71, 92
PRKG9356	4229356	Detroit Diesel 53, 71, 92
PRKG9362	5229362	Detroit Diesel 53, 71, 92
PRKG9366	5229366	Detroit Diesel 53, 71, 92
PRKG9372	5229372	Detroit Diesel 53, 71, 92
PRKG9422	P&B 5226422	Detroit Diesel 53
PRKG9608	5229608	Detroit Diesel 53, 71, 92
PRKG9776	5229776	Detroit Diesel 53, 71, 92
PRKG9808	5229808	Detroit Diesel 53, 71, 92



REF.NOZZLE	GENERAL MOTORS EMD ENGINE		ENGINES USED
	OTHER NO		
PRKEM6131	5226131	7-,0152-150	Engine EMD
PRKEM5641	5235641	6-,0165-150AL	Engine EMD
PRKEM7001	5227001	7-,015-150	Engine EMD
PRKEM9195	5229195	5-,0134-150	Engine EMD
PRKEM9230	5229230	6-,0134-150	Engine EMD
PRKEM9235	5229235	6-,012-150	Engine EMD
PRKEM9260	5229260	6-,012-150	Engine EMD
PRKEM9265	5229265	7-,014-160	Engine EMD
PRKEM9270	5229270	7-,012-160	Engine EMD
PRKEM9275	5229275	7-,012-160	Engine EMD
REF.NOZZLE	GENERAL MOTORS EMD ENGINE		ENGINES USED
	OTHER NO		
PRKEM6128	5226128		Engine EMD
PRKEM6464	5226464		Engine EMD
PRKEM7003	5227003		Engine EMD
PRKEM7853	5227853		Engine EMD
PRKEM8236	5228236		Engine EMD
PRKEM8574	5228574		Engine EMD
PRKEM8894	5228894		Engine EMD
PRKEM9011	5229011		Engine EMD
PRKEM9705	5229705		Engine EMD
PRKEM6153	5226153		Engine EMD
PRKEM8538	5228538		Engine EMD
PRKEM8571	5228571		Engine EMD
PRKEM8572	5228572		Engine EMD



REF.NOZZLE	LIGHT DUTY COMMERCIAL VEHICLES				ENGINES USED
	OEM NO	Make	Type	OE INJECTOR CODES	
PRKVX40060	F00VX40060	Bosch Piezo	Powerstroke	0 445 117 015 - 0 445 117 016 0 445 117 023 - 0 986 435 415	FORD F250/350 6.7 L (2011 - 2017)
PRKVX40115	F00VX40115	Bosch Piezo	Powerstroke	0 445 117 040 - 0 445 117 043 0 986 435 433	FORD F250/350/550/650/650 6.7 L
PRKVX40045	F00VX40045	Bosch Piezo	Duramax	0 445 117 008	CHEVROLET / GMC 6.6 L
PRKVX40051	F00VX40051	Bosch Piezo	Duramax	0 445 117 010	CEHEVROLET / GMC / SILVERADO 6.6 L
PRK6045A	CV0802P150	Navistar Nozzle	Navistar	1878284C91 - 1844751C2 - 184510C92 1846692C92 - 1877748C1 - 1878285C91	E 350 - E 450 VT365 6.0 L Nominal
PRK64P0810C	M0006P154	Siemens	PIEZO	1875072C91	F250 Superduty 6.4 L (2008 - 2010)
PRK143P5519	DSLA 143 P 5519	Cummins	5.9 L	0 445 120 255	Dodge Ram 1500-2500 5.9 L (2003-2004)
PRK124P5516	DSLA 124 P 5516	Cummins	6.6 L	0 445 120 208 - 0 445 120 238	Dodge Ram 1500-2500 6.6 L (2003-2004)
PRK3037041	DPE 410006/31	3037041 BG 3037041 BJ	Navistar HEUI	1830094C92 - 1830570C92 - 1830571C2 1830572C93	DTE466E 230 Hp to 250 Hp 1997-1999 1530E 230 Hp to 300 Hp 1999
PRK3037041	DPE 410006/31	3037041 BG 3037041 BJ	Navistar HEUI	1830573C2 - 2593596C91	DTE466E 230 Hp to 250 Hp 1997-1999 1530E 230 Hp to 300 Hp 1999
PRK3037047	DPE 410006/31	3037047 BI	Navistar HEUI	1830559C91 - 1830560C2 - 1830561C92 1830562C2 - 1830740C92 - 2593594C91	DTE466E 175 Hp to 250 Hp 1999 DTE466E 175 Hp to 250 Hp 2000-2003
PRK3037102	DPE41007/31	3037102 v8 AA - FF	Navistar HEUI	1833640C1 - 1833641C1	T444E 1997-2000





Caterpillar Injector & Pump Repair Kits

CAT 3406 E / C15 Injectors



A1-23868
Valve Set 3508E / 3406E
Use : Cat OR-4893 / 20R1275
Engine : CAT 3500E / 3508E / 3512E
3516E / 3406E / CAT C15



A1-23612 O'Ring Kit 3500E
10R1285 / 10R1290 / 192-2817 / 2501311
Engine : CAT 3500E – 3512E
3516E - 3508E



A1-23610 O'Ring Kit 3500E
10R1285 / 10R1290 / 192-2817 / 250-1311
Engine : CAT 3500E – 3512E
3516E - 3508E



A1-23246 O'Ring Kit 3500E
10R1285 / 10R1290 / 192-2817/ 250-1311
Engine : CAT 3500E - 3508E



A1-23484 O'Ring Kit 3406E
188-9030 / 188-9035 / 140-8993 / 211-2023
OR-4983 / OR4894 / OR9256 / CH10948
CH12071
Engine : CAT 3406 E / Perkins C15





Caterpillar Injector & Pump Repair Kits

CAT 3500E - 3406E / C15 Injectors



A1-23830 O'Ring Kit 3406E
188-9030 / 188-9035 / 140-8993 / 211-2023
0R-4983 / 0R4894 / 0R9256 / CH10948
CH12071

Engine : CAT 3406 E / Perkins C15



A1-23481 O'Ring Kit 3406E
188-9030 / 188-9035 / 140-8993 / 211-2023
0R-4983 / 0R4894 / 0R9256 / CH10948
CH12071

Engine : CAT 3406 E / Perkins C15



Nozzle With Adaptor

PRKCAT-0011 / **Use : CAT C12 = 251F851245**
PRKCAT-0012 / **Use : CAT C13 = 200T803444**
PRKCAT-0013 / **Use : CAT C18 = 226T903487**
PRKCAT-0014 / **Use : CAT C15 = 053T843484**





Caterpillar Injector & Pump Repair Kits

CAT 3126 HEUI Injectors



A1-23631 O'Ring Kit 3126E
Use : 173-9272 / 177-4754 / 196-1401
Engine : CAT 3126E



A1-23629 O'Ring Kit 3126E
Use : 173-9272 / 177-4754 / 196-1401
Engine : CAT 3126E



PRKCAT-0004 Solenoid 3126E
Use : 173-9272 / 177-4754 / 196-1401
OR9349
Engine : CAT 3126E



Caterpillar Injector & Pump Repair Kits

CAT C7 - C9 PUMP Repair Kit



A1-23005 Pump Repair Kit
CAT C7 - C9 pumps





A1-23641 Complete R/K C7-C9

Use Injectors : 238-8091 / 241-3239
 254-4339 / 263-8218 / 328-2582 / 387-9427
 387-9433 / 235-2888 / 236-0962 / 10R 7224
 10R-4761 / 10R-4762 / 10R-4763



A1-23640 R/K CAT C7-C9

Use Injectors : 238-8091 / 241-3239
 254-4339 / 263-8218 / 328-2582 / 387-9427
 387-9433 / 235-2888 / 236-0962 / 10R 7224
 10R-4761 / 10R-4762 / 10R-4763



A1-23639 R/K CAT C7-C9

Use Injectors : 238-8091 / 241-3239
 254-4339 / 263-8218 / 328-2582 / 387-9427
 387-9433 / 235-2888 / 236-0962 / 10R 7224
 10R-4761 / 10R-4762 / 10R-4763



A1-23821 Screw Kit CAT C7-C9

Use Injectors : 238-8091 / 241-3239
 254-4339 / 263-8218 / 328-2582 / 387-9427
 387-9433 / 235-2888 / 236-0962 / 10R 7224
 10R-4761 / 10R-4762 / 10R-4763



A1-23992 Actuator Kit C9

Use Injectors : 238-8091 / 241-3239
 254-4339 / 263-8218 / 328-2582 / 387-9427
 387-9433 / 235-2888 / 236-0962 / 10R 7224
 10R-4761 / 10R-4762 / 10R-4763



Caterpillar Injector & Pump Repair Kits

CAT C7 – C9 Injectors



A1-23992/C7 Actuator Kit C7

Use Injectors : 238-8091 / 241-3239
 254-4339 / 263-8218 / 328-2582 / 387-9427
 387-9433 / 235-2888 / 236-0962 / 10R 7224
 10R-4761 / 10R-4762 / 10R-4763



PRKCAT-0008 Actuator
 CAT C-7 – C9

OEM NO : 214-5427
Use Injectors : 238-8091 / 241-3239
 254-4339 / 263-8218 / 328-2582 / 387-9427
 387-9433 / 235-2888 / 236-0962 / 10R 7224
 10R-4761 / 10R-4762 / 10R-4763



PRKCAT-0007 Oil Pressure Valve
 CAT C-7 – C9

Use Injectors : 238-8091 / 241-3239
 254-4339 / 263-8218 / 328-2582 / 387-9427
 387-9433 / 235-2888 / 236-0962 / 10R 7224
 10R-4761 / 10R-4762 / 10R-4763



A1-23816/1 Intermediate Plate
 CAT C-7 – C9

Hight : 17.5 mm
Use Injectors : Cat C7 & C9 Injectors



A1-23816 Intermediate Plate
 CAT C9

Hight : 13.5 mm
Use Injectors : Cat C9 Injectors





PRKCAT-0009 P&B Assy
CAT C7 - C9

Hight : 13.5 mm

Use Injectors : Cat C9 Injectors



PRKCAT-N9427 **Nozzle CAT C7**
Injector No : 3879427 Inc. Adaptor

PRKCAT-N9433 **Nozzle CAT**
C9Injector No : 3879433 Inc. Adaptor



PRKCAT-0010 Body & Piston Assy
CAT C7 - C9

Use Injectors : Cat C7 & C9 Injectors



A1-23976/1 Nylon Gasket C7-C9
Rectangular

Use Injectors : Cat C7 & C9 Injectors



A1-23976/2 O-Ring C7-C9

Use Injectors : Cat C7 & C9 Injectors





Caterpillar Injector & Pump Repair Kits

CAT 320D - C 6.6 Injectors



A1-23004 Injector Repair Kit
CAT 320D / C6.6

Use Injectors : Cat 320D / C.6.6



PRKCAT-0002 Injector Solenoid
CAT 320D / C6.6

Use Injectors : Cat 320D / C.6.6



PRKCAT-1001 Nozzle Injector
CAT 320D / C6.6

Use Injectors : Cat 320D / C.6.6



32F61-00062 Injector Control
Valve CAT 320D / C6.6

Use Pump : Cat 320D / C.6.6





Caterpillar Injector & Pump Repair Kits

CAT 320D – C 6.6 Pump



A1-23004/1 Pump Repair Kit
CAT 320D / C6.6

Use Injectors : Cat 320D / C.6.6



PRKCAT-005C Pump Actuator
Complete
CAT 320D / C6.6

OEM NO : 312-5620
Use Pump : Cat 320D / C.6.6





PRK6032
Siemens



PRK6031
EDF100878



PRK6030
EDF100648



PRK6029A
Denso



PRK6029
Denso



PRK6037
Denso



PRK6027
Renault Megane I



PRK6026
Renault Master



PRK6025
Delphi



PRK6024
Delphi



PRK6023
Renault Master



PRK6022
Siemens



PRK6021
Denso



PRK6020
Ford Transit



PRK6021A
Ford Transit



PRK6012A
Siemens



PRK6018
Bosch Piezo



PRK6017
Volvo-Peugeot 407 Ford



PRK6016
Bosch 1.6 Ford
Volvo



PRK6011
Siemens



PRK6014
Bosch



PRK6012
Bosch CR



PRK6018A
Bosch Piezo



PRK6010
Ford Transit



PRK6003
Venturi Kit Euro 4-5



PRK6007
Venturi Kit
9109-904



PRK6009
Venturi Kit
9109-911A



PRK6005
Ford Mondeo

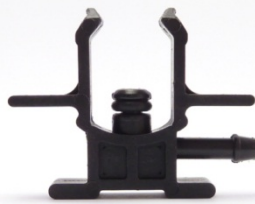

PRK6004
Ford Mondeo



PRK60036A
Mercedes Sprinter



PRK6002
Ford Fiesta – Citroen C3



PRK6001
Denso Transit



PRK6004A
Delphi Renault Megane I



PRK6048
Ford Transit



PRK6052
Bosch



PRK6051
Ford Fiesta – Citroen C3



PRK6049A
Mercedes



PRK6049
Mercedes



PRK6048A
Ford Transit



PRK6050
VW Crafter

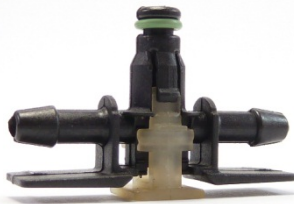

PRK6050A
VW Crafter



PRK6045
Bosch CR 2 Ways



PRK6044
Siemens Ford – Nissan
Volvo



PRK6043
Siemens Citroen
Peugeot Euro5



PRK6037A
Bosch C/R



PRK6041
Siemens 1 Way Volvo



PRK6042
Siemens 2 Ways Volvo



PRK6046
Bosch C/R One Way



PRK6040
Renault Dacia



PRK6036
MB Sprinter



PRK6033
VW – Aurdi – Skoda



PRK6028
Bosch Piezo 1 Way



PRK6028A
Bosch Piezo 2 Ways



PRK6035
Denso



PRK6053
Delphi Piezo – One Way
13537799993



PRK6053A
Delphi Piezo – Two Ways
13537799993



PRK6054A
Bosch (BMW) Piezo Two Ways



PRK6054
Bosch (BMW) Piezo One Way



PRK6055
Delphi Ref : YDT 479



PRK6056
Delphi Ref : YDT 480



PRK6020A
Delphi Ref YDT 478



PRK6058
MB Sprinter
Hose Set Pressure Limitter



PRK6059
Volkswagen - Audi - Skoda -
Seat 1.6 TDI Fuel Hose Set



PRK6060
Ford Transit 2.5 L
Pencil Injector



PRK6061
Bosch Piezo 2018 M. Year



PRK6062
VW-Audi-Seat 2.0 Tdi
Fuel Hose Non Return Valve



PRK6063A
New Bosch Piezo 2 Ways
0928400590 / 0986612922



PRK6063
New Bosch Piezo 1 Way
0928400590 / 0986612922



PRK6064
Bosch Piezo
Fuel Pipe Flow Control Valve
With 1 Inlet



PRK6065
Ford Mondeo Hose Set



PRK6066
Fiat Lancia
Waste Return One Way



PRK6066A
Fiat Lancia
Waste Return 2 Ways



PRK6067
Mercedes Euro 5
DELPHI - One Way



PRK6067A
Mercedes Euro 5
DELPHI - 2 Ways



PRK6068A
JCB Loader
2 Ways



PRK6068
JCB Loader
1 Way



PRK6070
Peugeot - Hyundai Euro5
1 Way



PRK6070A
Peugeot - Hyundai Euro5
2 Ways



PRK6057
Siemens New Type



PRK6071A
Delphi YDT 275
One Way



PRK6071
Delphi YDT 276
2 Ways



PRK6069
Hyundai - Peugeot
Type Delphi 1 Way



PRK6069A
Hyundai - Peugeot
Type Delphi 2 Ways



PRK6072
YDT 711
Type Delphi



PRK6006A
Injector Peugeot 2008



PRK6006
Hose Connector
VDO - Siemens

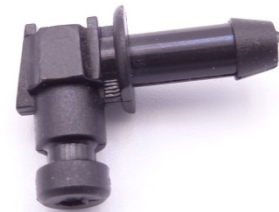

PRK5992
55578366
Opel Astra Corsa 1.7 CDTI
1 Way



PRK5993
55578366
Opel Astra Corsa 1.7 CDTI
2 Ways



PRK5994
Bosch Piezo
Fuel Pipe Flow Control Valve
With 2 Inlets



PRK5995
Ford Focus - Cmax II
1.6 TDCI C/R
2 Ways

Fuel WasteReturn Kits



PRK5996
Ford Focus - Cmax II
1.6 TDCI C/R
1 Way



PRK5998
Renault CLIO



PRK5999
Renault CLIO

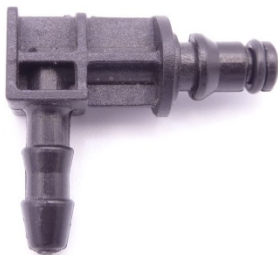

PRK6008
Renault CLIO

DELPHI - VDO Type CR Injector VALVES



- PRK308-621C** Control Valve 28538389 - 28440421
- PRK308-622B** Control Valve 28278897
- PRK308-625C** Control Valve 28392662 - 28277576 - 28362727

A1-26001 Control Valve with pin for VDO Piezo Injectors

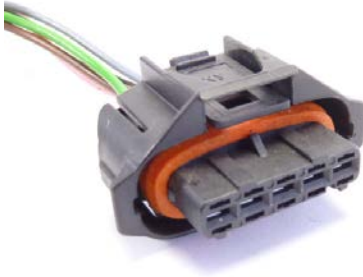

ED9700
5 Pin Bosch CR Pump



ED9698
Delphi Piezo Injector
MB – Hyundai I20
Ref Delphi 9001-886



ED5768
4 Pins Bosch CR Pump
Fiat Doblo & Similar



ED9695
Denso Rail Sensor
VDO (PCV) Sensor



ED5887
Denso CR Injector
Mitsubishi L200 & Similar

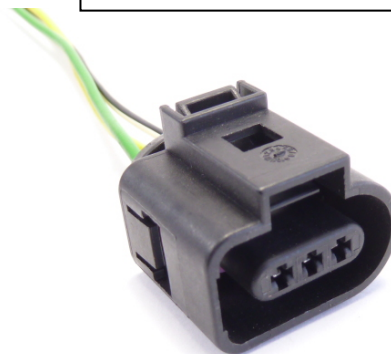

ED5783
VW Injector
3 Pins

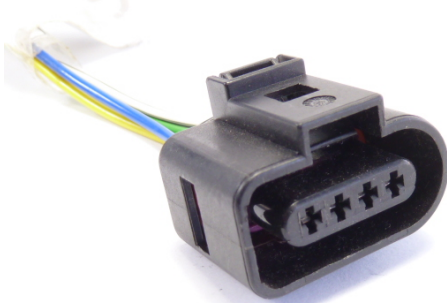

ED5782
VW Injectors
4 Pins

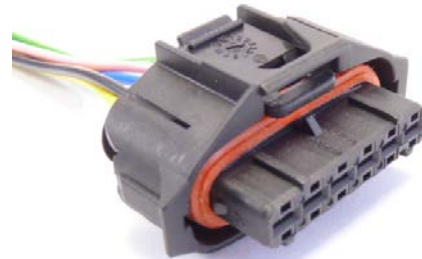

ED5759
Bosch Type
6 Pins

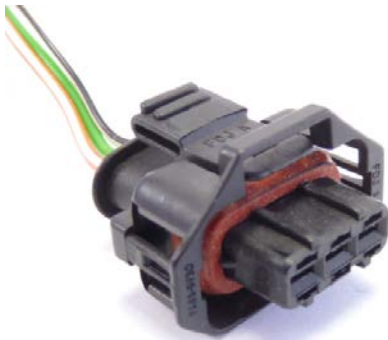

ED5694
Bosch Rail Sensor
3 Pins



ED5689
Universal type

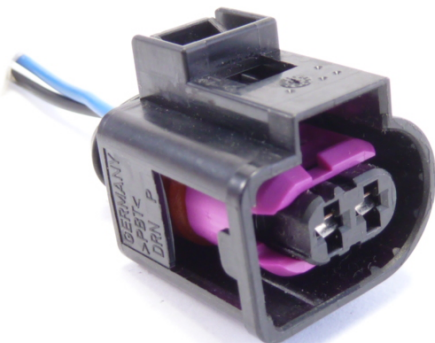

ED5681
VW CR Injector

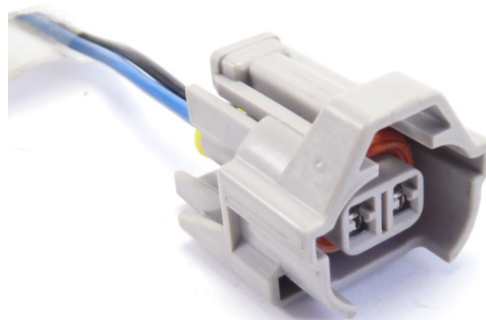

ED5547
Denso CR Injector
Denso CR Pump Sensor

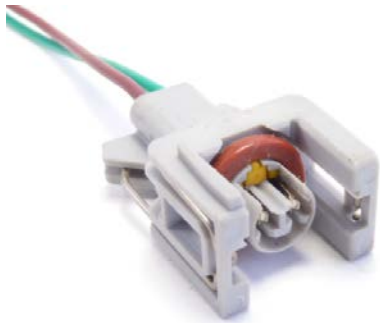

ED5678
Delphi CR Injector
Ref Delphi 9100-485



ED5539
VDO / Siemens Injector
Volkswagen

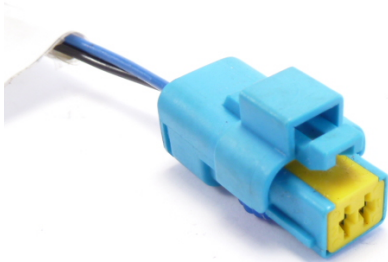

ED5542
Bosch Cp1 DRV Sensor
Siemens – Delphi DRV Sensor

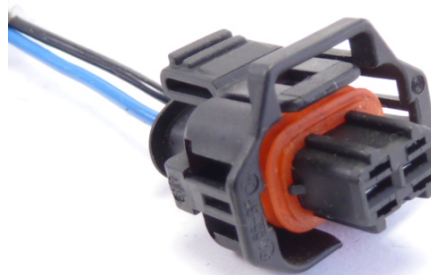

ED5506
Bosch CR Injector
2 Pins



ED5235
Denso Rail Sensor

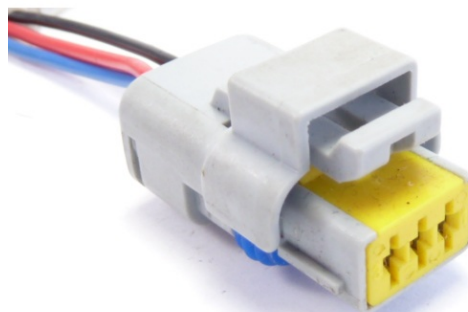

ED5538
Delphi Rail Sensor

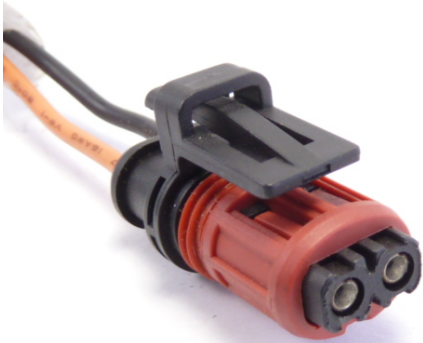

ED4069
Volvo 2 Pin EUI
Volvo FH Unit Injector

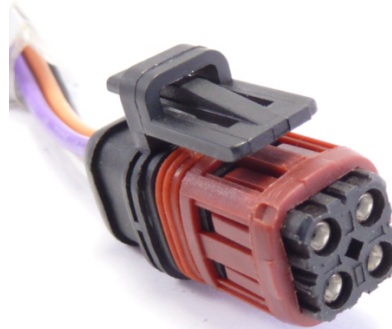

ED4070
Volvo 4 Pin EUI
Volvo FH Unit Injector

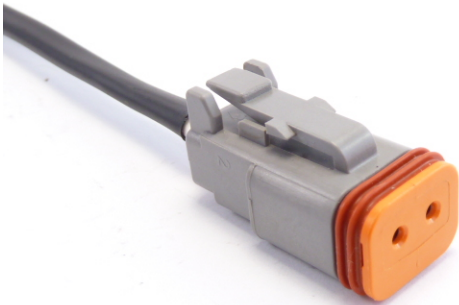

ED9898
Cummins Celect
Cummins N14 – M11 Injectors

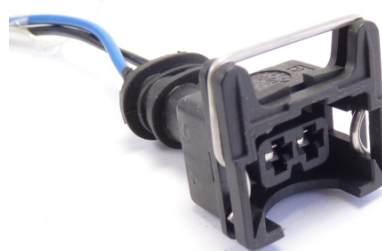

ED5094
Renault Kangoo
Volvo FH Unit Injector

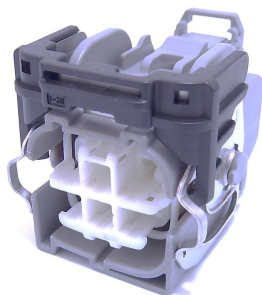

ED5507
Volvo 2.0 - Toyota
New Model Injector



10-15-254

PUMPS CP4 MONO PLUNGER - 1 OIL SEAL
Application: 0 445 010
506=507=508=530=543=546=563=580=704



10-15-254/6

PUMPS CP4 MONO PLUNGER - 1 OIL SEAL
Application: 0 445 010
516=552= 0 986 437 430

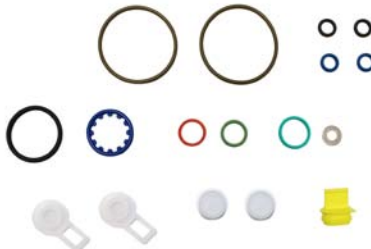

10-15-254/2

PUMPS CP4 ONE PLUNGER - NO OIL SEAL
Application: 0 445 010
506=507=508=530=543=546=563=580=704



10-15-254/7

PUMPS CP4 MONO PLUNGER - 1 OIL SEAL
Application: 0 445 010
767=768



10-15-254/3

PUMPS CP4 - suitable original code Bosch: 1 462 C15 999
Application: 0 445 011
504=506=507=512=515=519=755=828=856=0 986 437 457



10-15-255

PUMPS CP4 DOUBLE PLUNGERS - 2 OIL SEALS
Application: 0 445 010
611=659=669=673=685



10-15-254/4

PUMPS CP4 - suitable original code Bosch: 1 462 C16 997
Application: 0 445 011
504=506=507=512=515=519=755=828=856=0 986 437 457

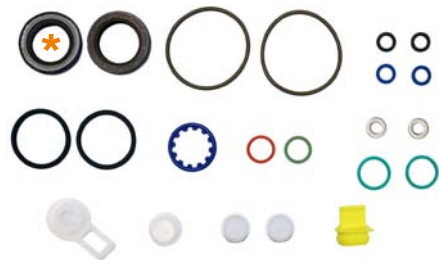

10-15-255/1

PUMPS CP4 DOUBLE PLUNGERS - 2 OIL SEALS (1 PTFE)
Application: 0 445 010
611=659=669=673=685

* AVAILABLE 2" VERSION
10-15-255/A > WITH "SUITABLE" PTFE OIL SEAL



10-15-254/5

PUMPS CP4 - 2 OIL SEALS
Application: 0 445 010
512=525=545=559= 0 986 437 437



10-15-255/2

PUMPS CP4 DOUBLE PLUNGERS - 2 OIL SEALS
Application: 0 445 010
622=649=851

Perk CODE	BOSCH REF	APPLIC. PUMPS		
A2-12001	1 466 C06 034	0 445 010 611		
		0 445 010 639		
		0 445 010 646		
		0 445 010 659		
		0 445 010 669		
		0 445 010 673		
		0 445 010 685		
		0 445 010 686		
		0 986 437 404		
		0 445 010 506		
A2-12002	1 466 C06 025	0 445 010 509		
		0 445 010 510		
		0 445 010 521		
		0 445 010 524		
		0 445 010 547		
		0 445 010 558		
		0 445 010 580		
		0 445 010 581		
		0 445 010 582		
		0 445 010 617		
		0 445 010 623		
		0 445 010 665		
		0 445 010 688		
		0 445 010 707		
		0 445 010 711		
		0 445 010 713		
		0 445 010 715		
		0 445 010 717		
		0 445 010 807		
		0 445 010 809		
		0 986 437 402		
		0 986 437 406		
		0 986 437 427		
		0 986 437 428		
		0 986 437 455		
		A2-12003	1 466 C06 030	0 445 010 507
				0 445 010 508
				0 445 010 520
0 445 010 541				
0 445 010 542				
1 466 C06 143	0 445 010 543			
	0 445 010 546			
	0 445 010 555			
	0 445 010 811			
	0 445 010 812			
A2-12004	1 466 C06 094	0 986 437 410		
		0 986 437 433		
		0 445 010 537		
		0 445 010 538		
		0 445 010 570		
A2-12005	1 466 C06 045	0 445 010 583		
		0 986 437 440		
		0 445 010 513		
		0 445 010 514		
		0 445 010 526		
		0 445 010 529		
		0 445 010 532		
		0 445 010 533		
		0 445 010 534		
		0 445 010 535		
		0 445 010 550		
		0 445 010 551		
		0 445 010 562		
		0 445 010 565		
		0 445 010 566		
		0 445 010 567		
		0 445 010 568		
		0 986 437 405		
		0 986 437 434		
		0 986 437 438		
A2-12006	1 466 C06 113	0 445 010 587		
		0 445 010 588		
		0 445 010 709		
		0 986 437 452		
		0 986 437 452		

Perk CODE	BOSCH REF	APPLIC. PUMPS
A2-12007	1 466 C06 076	0 445 010 519
		0 445 010 554
		0 445 010 723
		0 445 010 725
		0 986 437 425
		0 445 010 511
A2-12008	1 466 C06 082	0 445 010 522
		0 445 010 544
		0 445 010 556
		0 445 010 636
		0 445 010 637
	1 466 C06 064	0 445 010 684
		0 445 010 689
		0 445 010 690
		0 445 010 691
		0 445 010 696
A2-12009	1 466 C06 085	0 445 010 699
		0 445 010 740
		0 445 010 830
		0 445 010 831
		0 986 437 431
	1 466 C06 051	0 986 437 444
		0 986 437 463
		0 986 437 468
		0 445 010 624
		0 445 010 642
A2-12010	1 466 C06 110	0 445 010 650
		0 445 010 658
		0 445 010 675
		0 445 010 676
		0 445 010 677
	1 466 C06 054	0 445 010 682
		0 445 010 683
		0 445 010 692
		0 445 010 693
		0 445 010 801
A2-12011	1 466 C06 079	0 986 437 418
		0 986 437 435
		0 986 437 454
		0 445 010 517
		0 445 010 528
		0 445 010 553
		0 445 010 561
		0 445 010 573
		0 445 010 574
		0 445 010 627
		0 445 010 666
		0 445 010 719
		0 445 010 783
		0 445 010 784
		0 445 010 785
A2-12014	1 466 C06 088	0 445 010 794
		0 986 437 401
		0 986 437 424
		0 445 010 634
		0 445 010 638
A2-12015	1 466 C06 104	0 445 010 667
		0 445 010 678
		0 445 010 679
		0 445 010 808
		0 445 010 852
		0 445 010 853
		0 445 010 854
		0 445 010 855
		0 986 437 429
		0 986 437 453
A2-12015	1 466 C06 104	0 445 010 635
		0 445 010 540
		0 445 010 572
		0 445 010 721
		0 445 010 727
		0 445 010 755
		0 445 010 756
0 986 437 403		
0 986 437 457		

Perk CODE	BOSCH REF	APPLIC. PUMPS
A2-12017	1 466 C06 140	0 445 010 703
		0 445 010 759
		0 445 010 773
A2-12018	1 460 C06 091	0 445 010 645
		0 445 010 672
		0 986 437 458
A2-12019	1 466 C06 022	0 445 010 612
		0 986 437 465
A2-12020	1 466 C06 098	0 445 010 530
		0 445 010 704
		0 986 437 439
		0 986 437 442
A2-12021	1 466 C06 122	0 445 010 578
		0 445 010 579
		0 445 010 592
		0 445 010 738
		0 445 010 739
		0 986 437 445
		0 986 437 446
		0 445 010 516
A2-12023	1 466 C05 025	0 445 010 552
		0 986 437 430
		0 445 020 508
A2-12025	1 466 C05 037	0 445 020 516
	1 466 C05 055	0 445 020 522
A2-12026	1 466 C05 040	0 445 010 536
		0 445 010 539
		0 445 010 548
		0 445 010 549
		0 445 010 569
		0 445 010 571
		0 445 010 576
		0 445 010 577
		0 986 437 448
		0 986 437 449
		0 986 437 459
		0 986 437 460
		0 445 010 512
		0 445 010 525
A2-12027	1 466 C06 042	0 445 010 545
		0 445 010 559
		0 445 010 618
		0 445 010 655
	1 466 C06 200	0 445 010 680
		0 445 010 681
		0 986 437 423
		0 986 437 437
A2-12028	1 466 C05 031	0 445 010 614
		0 445 010 629
		0 445 010 662
		0 445 010 832
		0 986 437 432

Perk CODE	BOSCH REF	APPLIC. PUMPS
A2-12029	1 466 C06 128	0 445 010 824
		0 445 010 825
		0 445 010 868
A2-12030	1 466 C06 125	0 445 010 597
		0 445 010 598
A2-12031	1 466 C06 116	0 445 010 585
		0 445 010 586
		0 445 010 593
		0 445 010 594
		0 986 437 461
		0 445 010 613
A2-12032	1 466 C06 060	0 445 010 654
		0 445 010 656
		0 445 010 694
A2-12033	1 466 C05 011	0 445 010 619
		0 445 010 620
		0 445 010 663
		0 445 010 664
		0 986 437 414
		0 445 010 628
A2-12034	1 466 C05 034	0 445 010 835
		0 445 010 804
A2-12035	1 466 C06 137	0 445 010 810
		0 986 437 441
A2-12036	1 466 C06 152	0 445 010 737
		0 445 010 747
A2-12037	1 466 C06 179	0 445 011 519
		0 445 010 760
A2-12038	1 466 C05 076	0 445 010 761
		0 445 010 766
A2-12039	1 466 C05 067	0 445 010 803
A2-12040	1 466 C05 043	0 445 020 515
A2-12041	1 466 C06 101	0 445 020 525
		0 445 020 526
		0 445 020 527
		0 445 020 528
A2-12042	1 466 C05 094	0 445 010 874
A2-12043	1 466 C06 149	SOON AVAILABLE
A2-12044	1 466 C06 182	0 445 010 769
		0 445 010 840
		0 445 011 515
		0 445 011 535
A2-12045	1 466 C05 070	0 445 010 697
		0 445 010 698
		0 445 010 820



A2-12000/1 Perk

DESCR.
Original Reference: 1 462 C24 995
Valve Tappet & Roller Kit for
CP4 Bosch Pumps Mono or Double Plunger



A2-06113 Perk

DESCR.
Screw for Valve Tappet & Roller 12-12-000/1
(for positioning)
included o-ring



A2-12000 Perk

DESCR.
Original Reference: 1 462 C24 999
Valve Tappet & Roller Kit for
CP4 Bosch Pumps Mono or Double Plunger

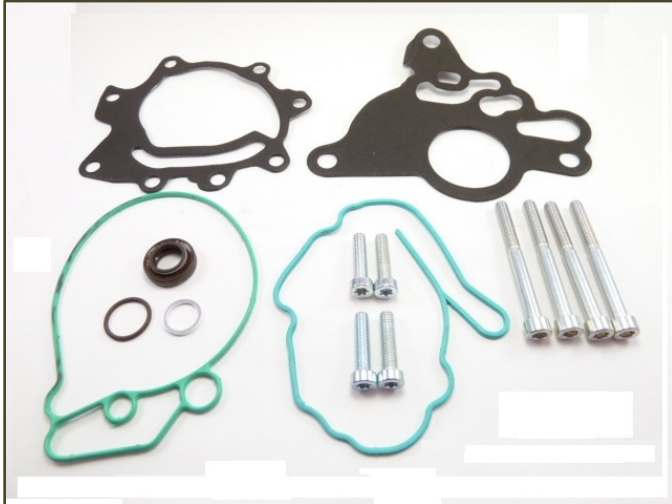

A1-23357

F 009 D00 069 = 03G 145 209 C

Use

AUDI A3/A4/A6 1.9 Tdi
 FORD Galaxy 1.9 Tdi
 SEAT Alahambra, Cordoba, Ibiza, Leon,
 Toledo II 1.4/1.9 Tdi
 SKODA Fabia, Octavia, Felicia, Superb 1.4/1.9 Tdi
 VOLKSWAGEN Golf Plus, Golf V, Jetta, Passat,
 Touran 1.9 Tdi

Model Year : 2003 - 2007

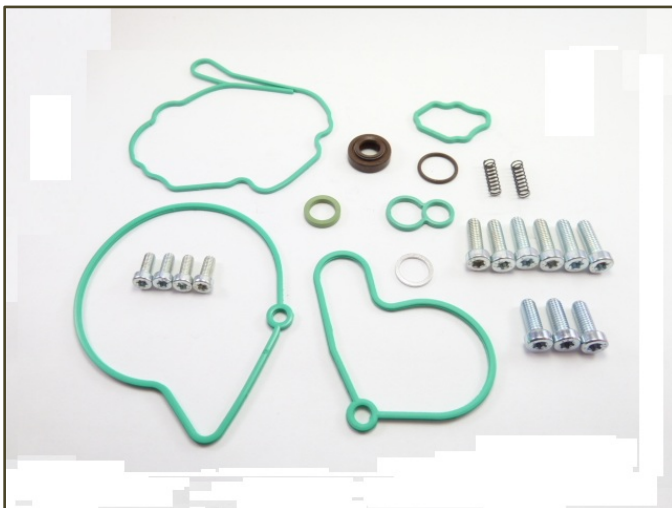

A1-23358

F 009 D00 001= 038 145 209 A

Use

AUDI A2 1.2 Tdi, A3, A4, A6 1.9Tdi
 SEAT Alahambra, Altea, Arosa, Cordoba, Ibiza
 IV, Leon, Toledo II 1.4/1.9Tdi
 SKODA Superb 1.9/2.0 Tdi
 VOLKSWAGEN Bora 1.9 Tdi, Caddy II/III, Eos 2.0
 Tdi, Golf IV/V, Jetta, Lupo, New
 Beetle, Passat, Polo, Sharan, Touran 1.9/2.0 Tdi/Sdi

Model year : 1995 - 2006

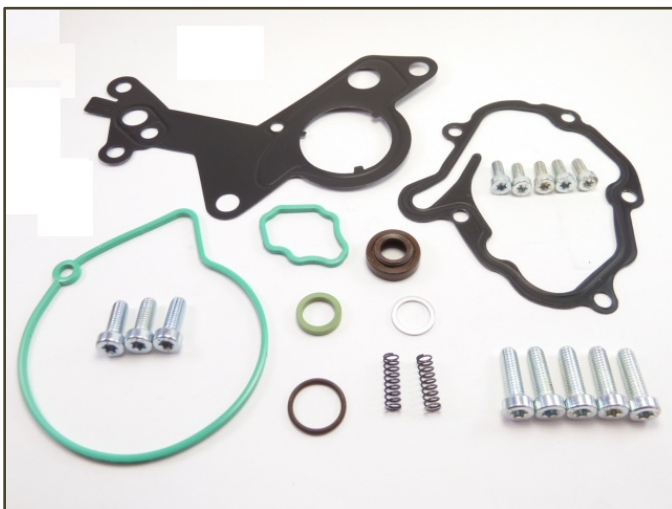

A1-23359

038 145 209 E=C=M

Use

AUDI A2 1.2 Tdi, A3, A4, A6 1.9/2.0 Tdi
 SEAT Alhambra, Arosa, Cordoba, Ibiza, Leon,
 Toledo, Vario 1.4 / 1.9 / 2.0 Tdi
 SKODA Fabia, Octavia, Roomster, Superb
 1.4/1.9/2.0 Tdi
 VW Beetle, Bora, Caddy, Fox, Golf IV, Lupo,
 Passat, Polo, Sharan, Touran 1.2/1.4/1.9/2.0 Tdi

Model year : 2000 -2008

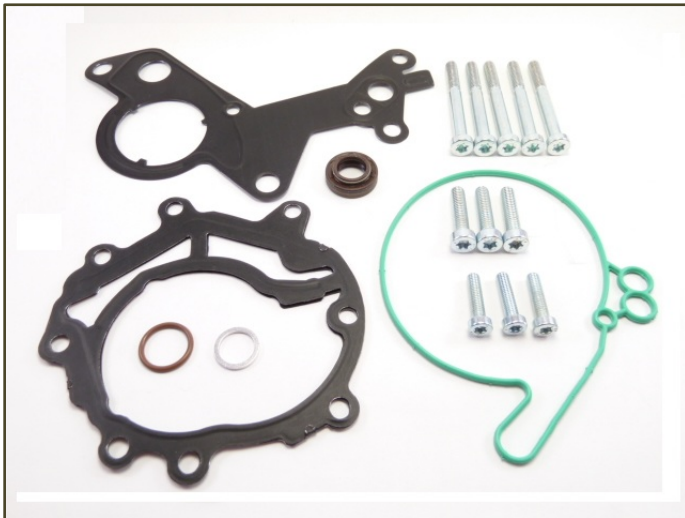

A1-23503

038145209M = 209Q / F 009 D02 008

Use

SEAT Altea, Ibiza, Leon 1.9/2.0 Tdi
VOLKSWAGEN Caddy, Golf Plus, Golf V
Jetta, Passat, Touran 1.9/2.0 Tdi / Sdi

Model year : 2005 - 2007

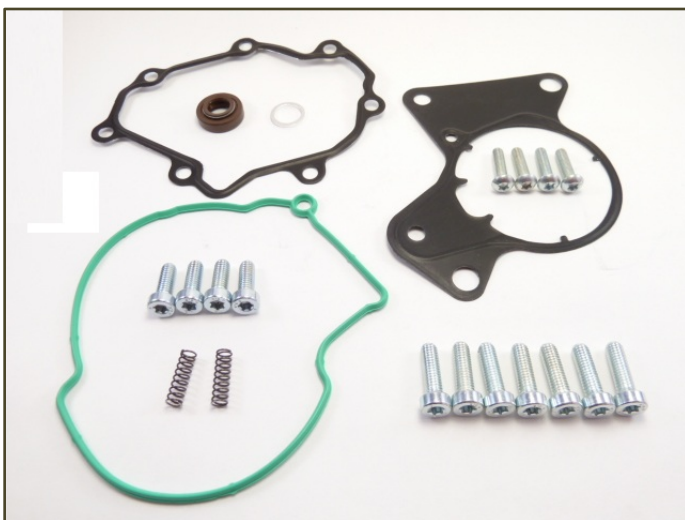

A1-23504

070145209H = F = J / 07Z145209B

Use

Volkswagen Transporter T5
Touareg 2.5 L 5 Cyl. Tdi
VW Phaeton, Touareg 5.0 L 10 Cyl. Tdi

Model year : 2003 - 2008



A1-23505

07Z127025F = E

Use

VOLKSWAGEN Phaeton,
Touareg 5.0 –10 Cyl. Tdi
Engine BLE / AYH

Model year : 2003 - 2008

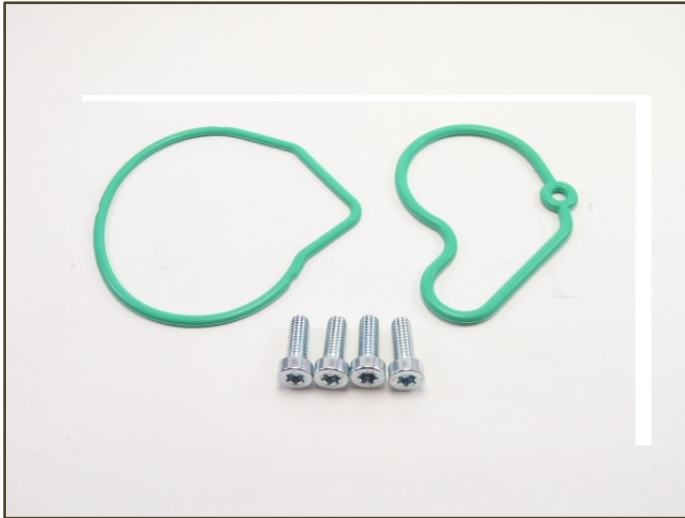

A1-23506

07Z127025F = E

Use

VOLKSWAGEN Beetle, Golf, Jetta 1.9 Tdi

Model year : 2003 - 2008



A1-23974

**03L 145100F - 03L145100G
F 009 D03 014**



A1-2339/1

**038 145 209 E=H=K
F 009 D2 008**

2000 - 2008

AUDI A2 1.2 Tdi, A3, A4, A6 1.9/2.0 Tdi

**SEAT Alhambra, Arosa, Cordoba, Ibiza, Leon,
Toledo, Vario 1.4/1.9/2.0 Tdi**

SKODA Fabia, Octavia, Roomster, Superb 1.4/1.9/2.0 Tdi

**VOLKSWAGEN Beetle, Bora, Caddy, Fox, Golf IV, Lupo,
Passat, Polo, Sharan, Touran 1.2/1.4/1.9/2.0 Tdi**



A1-23182 Cp3-110
A1-23182B Without Oil Seal
F 00N 201 976
 Cp3-110 Ford
 Cargo



A1-23-183 Cp3-70
F 00 N 201 974
 CP3-70
 MB Vito-Viano-Sprinter C,CLK,ML,CLS Series
 BMW



A1-23183/1 Cp3
Other 60.138
F 00 N 201 973 = 974 = 975 = 976
 MB Vito-Viano-Sprinter C,CLK,ML,CLS Series

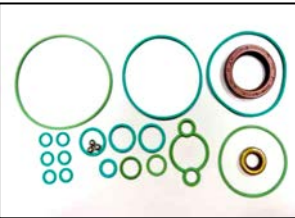

A1-23185 CP3
Other 60.139
F 00 N 201 975
 Oil Seals = 25 x 37 x 7 / 25 x 36 x 7.5 / 10 x 18.8 x
 5.2 Audi A 8 4.0-4.2 TDI
 MB C30 AMG, S 400 CDI E-G-ML Serileri
 BMW 320,X5-X3, Iveco Daily 35+40, Audi 4.2



A1-23191 With x2 Oil Seals Cp1
A1-23193 Cp1 (Type Without Oil Seal)
F 01M 101 454
 Iveco Daily
 MB Sprinter 2.2 / 200-220 Cdi Vaneo 1.7 Cdi /
 A160

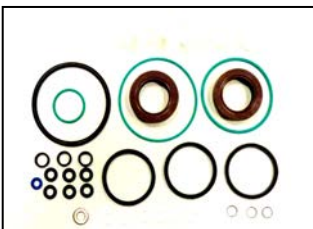

A1-23192 Cp1
A1-23194/2 Type without Oil Seals
F 01M 101 456 ilave Malzemeli
 Pump Cp1 2 Keçeli



A1-23331 Cp1H
Other 60.096/35
 Pump CP1 H
 1.9/2.4 JTD Multijet
 Opel Astra-Vectra-Zafira 1.9 Cdti

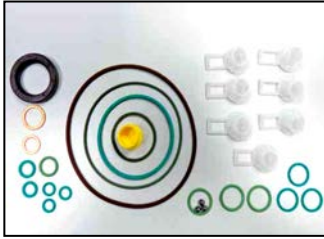

A1-23360
Other 60.183

Cp3

Pump CP3 MAN TGA



A1-23693
Other 60.096/40

Cp1-H

Pump 0 445 010 157

Pump Cp1 H
Fiat Doblo-Linea-Punto Evo-500 1.3 JTD 16 V
Opel Astra-Corsa 1.3 Cdti / Alfa Romeo Mito 1.3 JTD



A1-23696
Other 60.137/5

Cp2

0 445 020 012 - 013-003-004 and Similar

Renault Trucks Premium II - Midland II



A1-23698
Other 60.139/2

Cp3

Pump Ref 0 445 010 121 and similar

Hyundai SantaFe / Tucson / I30 / Sonata

KIA Carens / Yeni Sportage 2.0 - 2.2 Crdi



A1-23699
Other 60.139/4

Cp3

Pump Ref 0 445 010 and similar

MB S 320 Cdi / E 280-320 Cdi / ML 280-320 Cdi VITO 120 Cdi /

Sprinter 218-318-418 / Viano 3.0 Cdi



A1-23702
Other 60.139/9

Cp3

Pump Ref 0 445 010 101 = 052 and Similar

Hyundai H-1 / Starex / Matrix Kia Cerato / Sorento

1.5, 2.5 Crdi



A1-23706

Cp3

Other 60.185

Pumps 0 445 010 098-073-081-091-107-135-167-213

Iveco Daily 2.3-3.0 Jtd / Fiat Ducato 2.3 Jtd / Mazda BT 50
BMW 330-530-535 3.0 D / MB E 270-280-320 Cdi



A1-23710

Pump 0 445 020 043 and similar

Komatsu - Cummins



A1-23711

Cp1H

Other 60.190

Pump 0 445 010 170 and similar

Nissan Quashqai - X trail 2.0

RENAULT Trafic - Kaleos - Laguna III 2.0 Dci

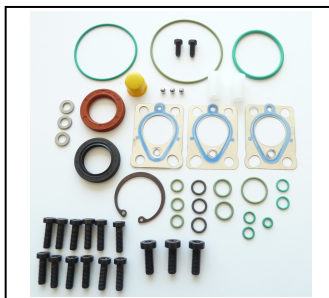

A1-09002

DFP3

Other 60139/10

7135-514

Delphi Pump DFP3

Audi A3-A4-A5-A6-Q5 / Seat Leon / Skoda Octavia-Suberb-Yeti 2.0 TDI
VW Amarak / Golf V-VI-Ketta-Multivan-Tiguan-Transpoter T5 2.0 TDI



A1-09169

7135-539

Delphi

7135 - 539 (7135 - 479 A) Delphi CR Pump

Renault Clio/Kangoo 1.5 Dci Ford Connect

Delphi Type CR pumps



A1-23703/1

VDO

Other 60.275

R/KIT Pump C/R Siemens Ford Transit **155 PS**

Pumps Used : 5WS40694=5WS40695)



A1-23281

VDO

Other 60.143/3

2 Gaskets + 2 Oil Seals Universal Type

SIEMENS-VDO CR Pumps

Peugeot 307,... / Citroen C4,C5

Volvo S40,V50, Ford C Max



A1-23247

VDO

Other 60143

X39-800-300-001Z

SIEMENS-VDO CR Pump Gasket Kit

Ford Connect,Mondeo,C Max

Nissan Qashqi 1.5 Dci,Peugeot Partner,Berlingo

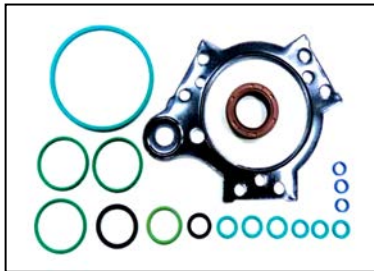

A1-23704

VDO

Other 60.143/8

X39-800-300-019

Siemens - VDO

5WS40157 = A2C59511314

Range Rover Sport / Discovery III

Jaguar XF - XJ - S Type / Peugeot 407-607 / Citroen C6



A1-23323

VDO

X39-800-300-004Z

Siemens - VDO

Screw & Plunger cover Gasket Kit



A1-23703/2

VDO

Other 60.274

R/KIT Pump C/R Siemens VW AUDI 1.6 Cai Engine

(Pumps Used 03L130755E=B=AH)

Pump with Start-Stop = 5WS40836

A2C59517047

Pump w/o Start-Stop = 5WS40891

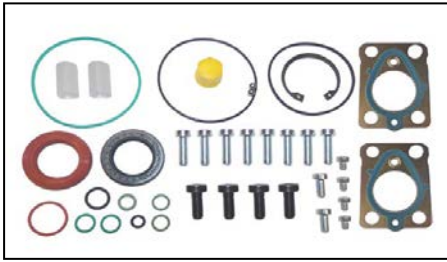

A1-09197 Punmp DFP3
7135-533 Delphi Type Universal
9424 A 050A
PSA DW10C type DFP3

Delphi



A1-23331/1
BOSCH Type Cp1H

Pumps 445 010 129 / 137 / 181 and similar



A1-23331/1
BOSCH Type Cp1H3 / R80

0 445 010 123 / 129 / 166 / 173 / 231 / 232 / 233 / 285

0 445 010 0294 / 308 / 309 / 349 / 350



A1-23936/2
Pump Ref : 0 445 020 075 Ex0 445 020 208

MAN TGA New Model with Gear Pump



A1-09208
Pumps Delphi Type Dfp3
33100-4A700



A0-15207
Other 60.166/4
 294009 - 0050 / 0051
DENSO HP4 CR Pump
 John Deere Tractor Series 30



A0-15208
 094040-0010
DENSO HP0 CR Pump



A0-15216
A0-15217
 294009-0032
DENSO HP3 CR Pump



A0-15209
 094040-0030
DENSO HP0 CR Pump



A0-15220
 294009 - 0031
DENSO HP3 CR Pump
 Toyota



A0-15244
Other 60.166/6
 294009 - 0110
 Ford Tourneo Connetc 2.2 Tdci



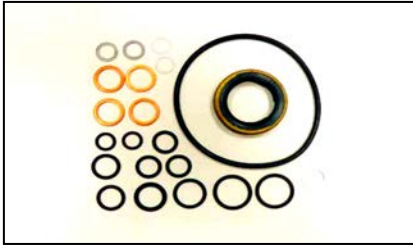

A0-15195
Other 60.166/5
 097490-0010 **097490 - 0010**
DENSO HP2 CR Pompa
 Toyota-Nissan Primera 2.2



A0-15196
Other 60.166
294009 - 0030
DENSO HP3 Pump C/R
 Toyota
 Nissan Almera, Primera 2.2



PRK180-0080 Transfer Pump 294180-0080
Oem 294180-0080
DENSO HP3 Pump C/R
 Toyota
 Nissan Almera, Primera 2.2



A1-09200 R/K DFP3 Pump Type Delphi
Oem 7135-526
DELPHI DFP3 Pump C/R
 9422A010A JCB 4.4L



Vehicle	Model Type	Injector No	Denso Ref	Nozzle	Valve No	Ex - Valve No	Plunger	Nut
CITROEN	Jumper	6C1Q-9K546AB	095000-580X	153 P 884-J	A1-50580	A1-30001	A1-31001	P2-04210
FIAT	DUCATO							
FORD	TRANSIT	6C1Q-9546AC						
PEUGEOT	BOXER							
FORD	TRANSIT	6C1Q-9K546BB	095000-581X	153 P 885-J	A1-50581	A1-30015	A1-31037	P2-04210
		6C1Q-9K546BC	095000-706X		A1-50706			
HYUNDAI	COUNTY	33800-4570X	095000-555X	150 P 866-J	A1-50555	A1-30004	A1-31038	P2-04210
	MIGHTY		095000-831X		A1-50831			
TOYOTA	COROLLA	23670-09140	095000-604X	155 P 876-J	A1-50604	A1-30002	A1-31002	P2-04233
		23670-09210	095000-623X		A1-50623			
TOYOTA	VERSO	23670-09290	095000-691X	155 P 1028-J	A1-50691			
		23670-0R020	095000-727X	155 P 876-J	A1-50727			
TOYOTA	RAV 4	23670-0R070	095000-728X	155 P 876-J	A1-50728			
		23670-0R120	095000-763X	155 P 876-J	A1-50763			
		23670-0R170	095000-764X	155 P 1028-J	A1-50764			
TOYOTA	HI-LUX 2.5	23670-09070	095000-544X	155 P 863-J	A1-50544	A1-30005	A1-31005	P2-04233
		23670-09330	095000-592X		A1-50592			
		23670-0L020	095000-754X	155 P 1025-J	A1-50754			
		23670-0L050	095000-778X		A1-50778			
		23670-30280	095000-822X	155 P 1062-J	A1-50822			
		23670-39316	095000-829X		A1-50829			
TOYOTA	LAND CRUISER	23670-30220	095000-741X	155 P 1025-J	A1-50741	A1-30005	A1-31005	P2-04233
		23670-39215			A1-50676			
		23670-30140	095000-676X		A1-50703			
		23670-39185	095000-703X		A1-50574			
		23670-30080	095000-574X		A1-50589			
		23670-30180	095000-589X		A1-50687			
		23670-30210	095000-687X		A1-50735			
		23670-30320	095000-735X		A1-50736			
		23670-39135	095000-736X		A1-50772			
		23670-39155	095000-772X					



Vehicle	Model Type	Injector No	Denso Ref	Nozzle	Valve No	Ex - Valve No	Plunger	Nut
TOYOTA	LAND CRUISER	23670-39295	095000-773X	155 P 1025-J	A1-50773	A1-30005	A1-31005	P2-04233
TOYOTA	HIACE	23670-09060	095000-552X	145 P 864-J	A1-30552	A1-30005	A1-31005	P2-04233
		23670-09360	095000-593X		A1-30593			
		23670-0L010	095000-619X		A1-30619			
		23670-0L070	095000-738X	145 P 1024-J	A1-30738			
		23670-30100	095000-739X		A1-30739			
		23670-30240	095000-775X		A1-30775			
		23670-30300	095000-776X		A1-30776			
		23670-39235	095000-874X		A1-30874			
		23670-39275	095000-593X	145 P 864-J	X			
		23670-30150	095000-677X	150 P 966-J	A1-30677			
		23670-30250	095000-704X	150 P 966-J	A1-30704			
		23670-30310	095000-742X	150 P 966-J	A1-30742			
		23670-39145	095000-743X	150 P 966-J	A1-30743			
		23670-39245	095000-779X	150 P 1026-J	A1-30779			
		23670-39285	095000-780X		A1-30780			
TOYOTA	LAND CRUISER	23670-51020	095000-673X	155 P 970-J	A1-30673	A1-30008	A1-31002	P2-04233
		23670-51030	095000-753X	155 P 970-J	A1-30753			
		23670-51031	095000-770X	155 P 970-J	A1-50770			
		23670-59025	095000-771X	155 P 970-J	A1-50771			
		23670-59035	095000-978X	155 P 970-J	A1-50978			
		23670-51041	095000-977X	155 P 971-J	A1-50977	A1-30008	A1-31002	P2-04210
TOYOTA	AVENSIS	23670-09190	095000-668X	155 P 960-J	A1-50668	A1-30017	A1-31002	P2-04233
	AURIS	23670-09230	095000-697X	155 P 960-J	A1-50697			
	COROLLA	23670-09270	095000-732X	155 P 960-J	A1-50732			
	VERSO	23670-0R050	095000-733X	155 P 960-J	A1-50733			
	RAV 4	23670-0R130	095000-768X	155 P 960-J	A1-50768			
	AVENSIS	23670-0R180	095000-769X	155 P 960-J	A1-50769			
	AVENSIS	23670-09130	095000-561X	155 P 871-J	A1-50561	A1-30019	A1-31002	P2-04233



DENSO Type Injector Repair Kits



Vehicle	Model Type	Injector No	Denso Ref	Nozzle	Valve No	Ex - Valve No	Plunger	Nut
TOYOTA	AVENSIS	23670-09200	095000-611X	155 P 871-J	A1-50611	A1-30019	A1-31002	P2-04233
		23670-09260	095000-690X	155 P 871-J	A1-50690			
		23670-0R010	095000-724X	155 P 871-J	A1-50724			
		23670-0R060	095000-725X	155 P 871-J	A1-50725			
		23670-0R110	095000-760X	155 P 1027-J	A1-50760			
		23670-0R160	095000-761X	155 P 1027-J	A1-50761			
		23670-09030	095000-512X	150 P 1023-J	A1-50512	A1-30009	A1-31026	
		23670-09220	095000-542X	150 P 1023-J	A1-50542			
		23670-09250	095000-689X	150 P 1023-J	A1-50689			
		23670-0G010	095000-721X	150 P 1023-J	A1-50721			
		23670-0G020	095000-722X	150 P 1023-J	A1-50722			
		23670-0G030	095000-755X	150 P 1023-J	A1-50755			
		23670-0G040	095000-758X	150 P 1023-J	A1-50758			
TOYOTA	AURIS	23670-09180	095000-641X	155 P 939-J	A1-50641	A1-30009	A1-31002	P2-04233
		23670-09240	095000-696X	155 P 939-J	A1-50696			
	AVENSIS	23670-09280	095000-730X	155 P 939-J	A1-50730			
		23670-0R030	095000-731X	155 P 939-J	A1-50731			
	COROLLA	23670-0R140	095000-766X	155 P 939-J	A1-50766			
		23670-0R190	095000-767X	155 P 939-J	A1-50767			
	DYNA 200	23670-79026	095000-652X	155 P 1044-J	A1-50652			
HINO	23670-E0091							
TOYOTA	LAND CRUISER	23670-30070	095000-525X	148 P 818-J	A1-50525	A1-30005	A1-31026	P2-04233
		23670-39086						
TOYOTA	HI-LUX (3.0)	23670-09380	295050-080X	G3S33	A1-51080	A1-30007	A1-31039	P2-04233
	HIACE	23670-0L110	295050-081X	G3S33	A1-51081			
	DYNA	23670-30420	295050-062X		A1-51062			
		23670-39425	295050-054X	G3S33	A1-51054			
TOYOTA	HI-LUX III	23670-30400	295050-046X	G3S6	A1-51046			
	LAND CRUISER	23670-39365	295050-020X	G3S6	A1-51020			



DENSO Type Injector Repair Kits



Vehicle	Model Type	Injector No	Denso Ref	Nozzle	Valve No	Ex - Valve No	Plunger	Nut
TOYOTA	HIACE IV	23670-09340	295050-019X	G3S7	A1-51019	A1-30007	A1-31039	P2-04233
		23670-0L100	295050-021X	G3S7	A1-51021			
		23670-30410	295050-047X	G3S7	A1-51047			
		23670-3955	295050-053X	G3S7	A1-51053			
MAZDA	MPV	RF5C13H50A	095000-503X	152 P 805-J	A1-50503	A1-30004	A1-3004	P2-04234
		RF5C13H50B	095000-587X	152 P 805-J	A1-50587			
	6	RFY013H50A	095000-785X	152 P 805-J	A1-50785			
		RFY013H50B	095000-883X	152 P 805-J	A1-50883			
	3	RF7J13H50	095000-578X	154 P 881-J	A1-50578	A1-30015	A1-31012	P2-04234
	5							
	6							
	3	R2AA13H50	295050-001X	G3S51	A1-51001	A1-30007	A1-31017	P2-04210
6								
CX-7								
NISSAN	X-TRAIL	16600-ES60A	095000-602X	152 P 917-J	A1-50602	A1-30008	A1-31008	P2-04210
	NAVARA	16600-EC00A	095000-625X	152 P 947-J	A1-50625	A1-30010	A1-31021	P2-04210
		16600-EB700						
	PATHFINDER	16600-EB300	095000-565X	148 P 872-J	A1-50565			
	ALMERA PRIMERA X-TRAIL	16600-AW400	095000-507X	148 P 816-J	A1-50507	A1-30008	A1-31025	P2-04210
		16600-AW420	095000-513X	148 P 816-J	A1-50513			
		16600-BN800	095000-517X	148 P 824-J	A1-50517			
16600-BN820		095000-518X		A1-50518				
CABSTAR	16600-MB40A	095000-624X	148 P 932-J	A1-50624	A1-30008	A1-31021	P2-04210	
MITSUBISHI	PAJERO	1465A054	095000-576X	145 P 875-J	A1-50576	A1-30003	A1-31003	P2-04210
	MONTERO							
	L200	1465A041	095000-560X	145 P 870-J	A1-50560	A1-30018	A1-31011	P2-04210
		1465A257	095000-956X	145 P 1030-J	*	*	A1-31040	*
1465A367		295050-089X	G3S45	A1-51089	A1-30021	A1-31041	P2-04210	



DENSO Type Injector Repair Kits



Vehicle	Model Type	Injector No	Denso Ref	Nozzle	Valve No	Ex - Valve No	Plunger	Nut
SUBARU	IMPREZA	16613AA020	095000-789X	159 P 990-J	A1-50789	A1-30004	A1-31009	P2-04234
	FORESTER							
	LEGACY							
	OUTBACK							
OPEL	ASTRA	8-97376270-X	095000-613X	148 P 924-J	A1-50613	A1-30016	A1-31007	P2-04235
	CORSA							
	MERIVA							
	ZAFIRA	8-97313861-X	095000-508X	148 P 817-J	A1-50508	A1-30020	A1-31010	P2-04235
	COMBO							
	CORSA							
OPEL	SIGNUM	8-97353080-X	095000-583X	152 P 898-J	A1-50583	A1-30008	A1-31016	P2-04210
	VECTRA							
RENAULT	ESPACE							
	VEL YATIS							
SAAB	9-5							
	9-6							
HINO	P11C	23910-1252	095000-521X	150 P 835-J	A1-50521	A1-30012	A1-31020	P2-04247
	J08E	23670-E0010	095000-659X	155 P 842-J		A1-30004	A1-31024	P2-04248
	700 - SERIES	23910-1240	095000-522X	158 P 834-J	A1-50522	A1-30004	A1-31023	P2-04247
		23670-E0340						
	23670-E0341							
JOHN DEERE	Tractor 4045 T	RE529117	095000-650X	139 P 825-J	A1-50650	A1-30004	A1-31036	P2-04250
			095000-872X		A1-50872			
SINO TRUCK		801 *	095000-801X	145 P 1029-J	A1-50801	A1-30013	A1-31014	P2-04209
		670 *	095000-670X	155 P 965-J	A1-50670		A1-31019	
		810 *	095000-810X	150 P 1052-J	A1-50810			
DONGFENG	XICHA	CA6DL-32	095000-622X	150 P 927-J	A1-50622	A1-30014	A-31018	P2-04197
XCMG		D28-001-801+C	095000-679X	155 P 964-J	A1-50679	A1-30004	A1-31022	P2-04210
LIUGONG								



DENSO Type Injector Repair Kits

Injectors with Valve Set (Double Valve)



Vehicle	Model Type	Injector No	Denso Ref	Nozzle	Valve No	Ex - Valve No	Plunger	Nut
TOYOTA	LAND CRUISER	23670-30010	095000-052X	G3S6	A1-60052	A1-32001	A1-31027	P2-04197
		23670-30020	095000-053X	155 P 753-J	A1-60053			
		23670-39015	095000-074X		A1-60074			
		23670-39025	095000-075X	155 P 753-J	A1-60075			
	AVENSIS	23670-27030	095000-057X	147 P 747-J	A1-60057	A1-32001	A1-31029	P2-04211
	AVENSIS VERSO							
	PREVIA	23670-29035	095000-042X	147 P 747-J	A1-60042	A1-32001	A1-31028	P2-04211
	RAV 4							
	COROLLA	23670-27020	095000-043X	147 P 752-J	A1-60043	A1-32001	A1-31029	P2-04211
	COROLLA VERSO	23670-29025	095000-064X	147 P 752-J	A1-60064			
	4 RUNNER	23670-30030	095000-077X	147 P 788-J	A1-60077	A1-32001	A1-31029	P2-04211
	DYNA	23670-30040	095000-063X	147 p 788-J	A1-60063			
HIACE	23670-39035	095000-094X	147 P 788-J	A1-60094				
HI-LUX	23670-39045	095000-095X	147 P 788-J	A1-60095				
NISSAN	PRIMERA	16600-AU600	095000-088X	148 P 800-J	A1-60088	A1-32001	A1-31010	P2-04210
OPEL	SIGNUM	8-97239161-7	095000-036X	155 P 750-J	A1-60036	A1-32001	A1-31031	P2-04211
	VECTRA							
RENAULT	SPACE							
	VEL YATIS							
SAAB	9-5							
JOHN DEERE	6081T	RE501010	095000-055X	148 P 764-J	A1-60055	A1-32002	A1-31032	P2-04210
KOMATSU	SA6D140		095000-056X	143 P 761-J	N/A	N/A	A1-31033	P2-04209
	SAA6D125		095000-121X	142 P 852-J	N/A	N/A	A1-31034	P2-04209



Vehicle	Model Type	Injector No	Denso Ref	Nozzle	Valve No	Ex - Valve No	Plunger	Nut
Toyota	Hi-Lux	23670-0E010	295700-0520	G4S009	A1-36004			P2-04233
	1GD-FTV	23670-11010	295700-0150					
	2.8 L	23670-19015	295700-0160					
	Euro 6	23670-09420	295700-0550					
			DCRI400520					
Toyota	Hi-Lux	23670-0E020	295700-0520	G4S008	A1-36004			P2-04233
	1GD-FTV	23670-11020	295700-0150					
	2.4 L	23670-19025	295700-0160					
	Euro 6	23670-09430	295700-0550					
			DCRI400520					



PRKINJ-6491 (with nozzle Dlla 139 P 887)
Oem : 095000-6491
 Complete Injector New JOHN DEERE
 RE529118



PRKINJ-7761 (with nozzle Dlla 145 P 1024)
Oem : 095000-7761 (7760) / 23670-30300
 Complete Injector New TOYOTA 2KD



PRKINJ-0L090 (with nozzle Dlla G3s6)
Oem : 295050-052# / 23670-0L090 / 23670-30400
23670-09350 / 295050-018#
 Complete Injector New TOYOTA HiLux 2.5D 3.0D
 2KD-FTV & 1KD Toyota D-4D, Euro 4

PRKINJ326-4700 (Common rail Type)
Oem : 326-4700 / 326-4756
 CAT ref **10R7575**
 CAT 320 D C6.6 Injectors



DENSO Type Injector Repair Kits

DENSO Type Injector Repair Kits

Isuzu Common Rail Injector

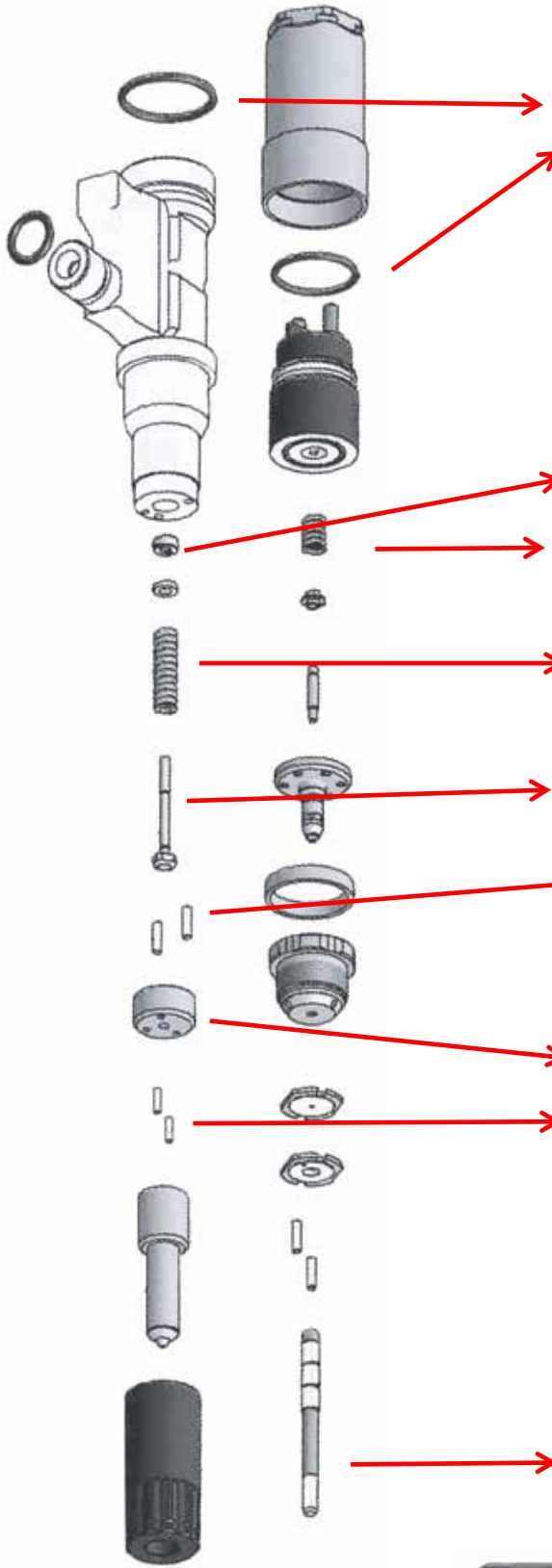

A4-10245	O'Ring
A4-10244	O'Ring

A1-23444	Spring Seat
-----------------	-------------

P2-02073	Spring
-----------------	--------

P2-02072	Pressure Spring
-----------------	-----------------

A1-23443	Pin	Ø2.7 31.8mm
A1-23742	Pin	Ø2.7 23.6mm

A1-23226	Pin	Ø1.8 6mm
-----------------	-----	----------

P2-03079	Injector spacer
-----------------	-----------------

A1-23445	Pin	Ø2.5 8.7mm
-----------------	-----	------------

For plungers please see our valve catalog



A6-01024 Valve dismantling tool Set



A6-01004 Valve Dismantling socket set

DENSO Type Injector Repair Kits

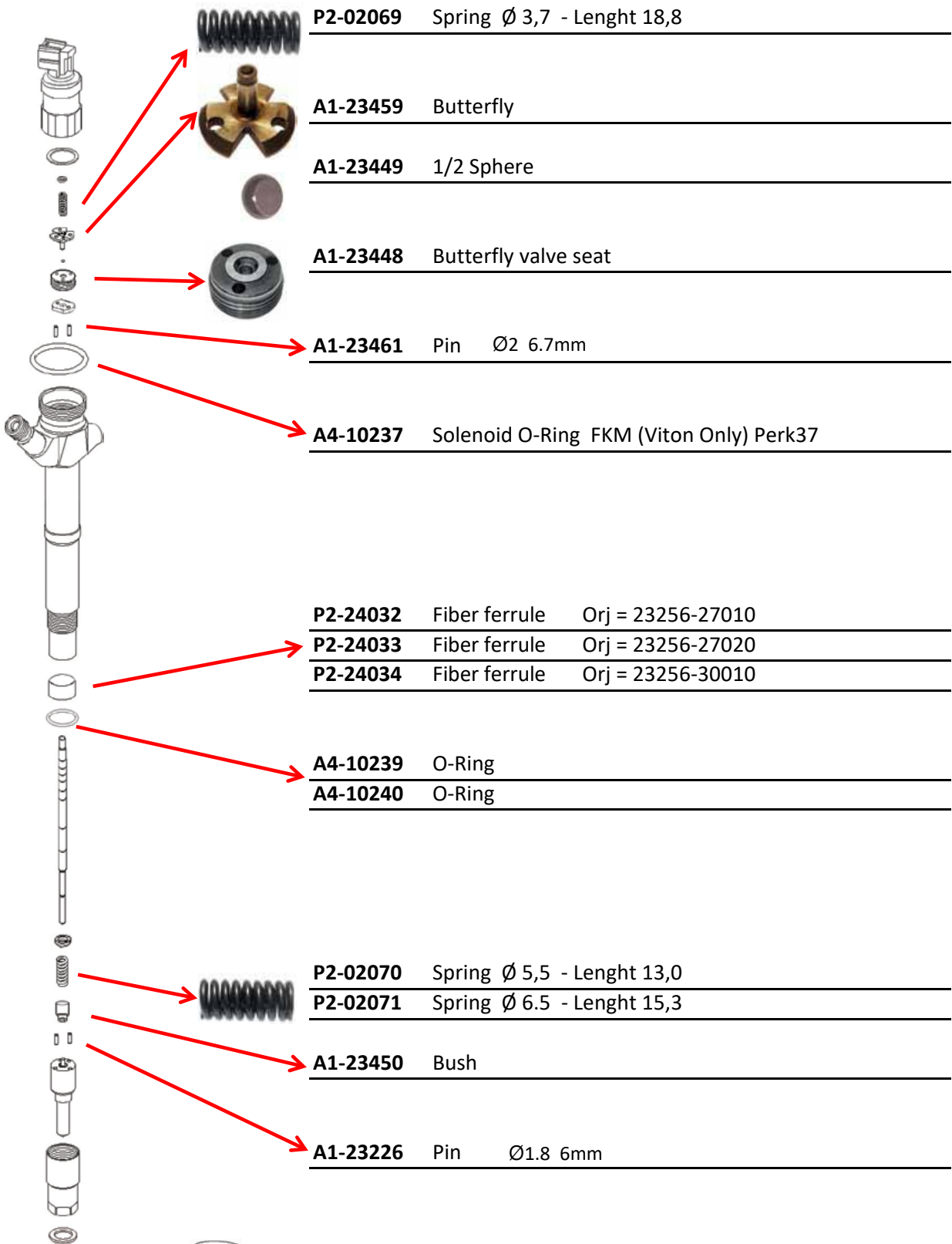

P2-02069 Spring Ø 3,7 - Lenght 18,8

A1-23459 Butterfly

A1-23449 1/2 Sphere

A1-23448 Butterfly valve seat

A1-23461 Pin Ø2 6.7mm

A4-10237 Solenoid O-Ring FKM (Viton Only) Perk37

P2-24032 Fiber ferrule Orj = 23256-27010

P2-24033 Fiber ferrule Orj = 23256-27020

P2-24034 Fiber ferrule Orj = 23256-30010

A4-10239 O-Ring

A4-10240 O-Ring

P2-02070 Spring Ø 5,5 - Lenght 13,0

P2-02071 Spring Ø 6.5 - Lenght 15,3

















A1-23450 Bush

A1-23226 Pin Ø1.8 6mm



Please check our valve catalog

DENSO Type Injector Repair Kits

	A1-23452	Butterfly valve	
	A1-23453	Butterfly valve seat	
	A1-23445	Pin	Ø2.5 8.7mm
	A4-10239	Body O-Ring	Ø 17 x 2
	A4-10240	Body O-Ring	Ø 15 x 2.3
	A1-23451	Injector Body O-Ring Kit	A4-15237 + 240
	A1-23458	Injector Body O-Ring Kit	A4-15237 + 239
	A1-23460	Pin	Ø1.8 14.1mm
	P2-03081	Inj. Spacer	Ø15.3 8mm
	P2-03065	Inj. Spacer	Ø16.3 8mm
	P2-03069	Inj. Spacer	Ø16.3 8mm
	A4-05303	Heat Shield	11176-30011
	P2-09101	Heat Shield	Ø 17 x3,0 11176-26010
	A4-05317	Heat Shield	Ø 16 x2,0 11176-30010
	A4-05318	Heat Shield	11176-26030
	P2-09084	Heat Shield	Ø 17 x3,5 11176-27010
	A4-05329	Heat Shield	11176-26020



P2-07079 Fuel waste return one way - Ford Transit & Similar



P2-07080 Fuel Waste Return two ways - Ford Transit & Similar



P2-07078 INJ. Base washer type Denso



P2-07077 Clips Fuel waste return type Denso



P2-07-081 Fuel waste return kit 2 ways - Ford Transit



P2-07076 Fuel waste reytturn kit one way - Ford Transit



A4-10044 O-Ring Denso CR Injector



A4-10248 Fuel waste return O-Ring





ED3152-0320 Filter for Denso Injector inlet



A6-01063/1 Denso Injector Filter Mounting - Dismantling Tool Kit

DENSO Type Injector Repair Kits

DENSO Type CR Injector Nozzle Cap Nuts

		
Perk ref P2-04242	Perk ref: P2-04247	Perk ref: P2-04248
Oem Injectors Used		
095000-056#	ISUZU	095000-058#
095000-080#	Manufacturer	095000-635#
095000-121#	HINO	095000-658#
095000-500#	Injector No	095000-659#
095000-501#	095000-522#	
095000-551#		
095000-670#		
095000-801#		
095000-810#		
614007L0127		

DENSO Type CR Injector Nozzle Cap Nuts

							
Perk ref : P2-04210							
CAR MAKER	DENSO INJ REF	MARCA	CAR MAKER	DENSO INJ REF	MARCA	CAR MAKER	DENSO INJ REF
1465A041	095000-5600	TOYOTA	23670-0R010	095000-5600	TOYOTA	23670-27030	095000-0570
1465A054	095000-5760	TOYOTA	23670-30140	095000-5760			
NISSAN 16600-AW40	095000-5130	TOYOTA	23670-0R050	095000-5130			
NISSAN 16600-ES60	095000-6020	TOYOTA	23670-30300	095000-6020			
		TOYOTA	23670-30280	095000-0530			
Perk ref : P2-04197							
CAR MAKER	DENSO INJ REF	MARCA	CAR MAKER	DENSO INJ. REF	MARCA	CAR MAKE	DENSO INJ REF
TOYOTA 23670-27030	095000-0530	SUBARU	16613AA020	095000-7890	OPEL	8-97313861-2	095000-0570
		MAZDA	RF5C13H50A	095000-5031	OPEL	8-97376270-1	095000-6130
		MAZDA	RF7J13H50	095000-5780			
Perk ref: 02-04-236							
CAR MAKER	DENSO INJ REF	MARCA	CAR MAKER	DENSO INJ. REF	FOR INJECTORS		
TOYOTA 23670-0R040	-	ISUZU	HINO	095000-522	095000-058#	095000-658#	
FOR INJECTORS DENSO PIEZO					095000-635#	095000-659#	

MICRO ABRASIVE BRUSHES



FEATURES:

**CORE OF GALVANIZED STEEL WIRE ,
SINGLE SPIRAL . AVAILABLE IN SILICON
CARBIDE OR ALUMINUM OXIDE NYLON FILL
MATERIAL . FLEXIBILITY PROVIDES EXCELLENT
CLEANING ACTION .**

APPLICATIONS:

**DEBURRING CROSS HOLES , VALVES AND
SMALL WIRES CLEAN**

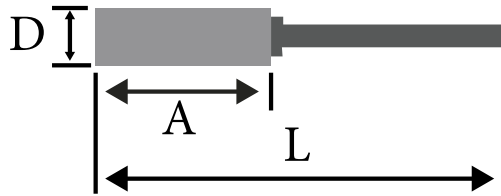

DIMENSIONS			DIAMETER	MATERIAL		QT.
D (MM)	A (MM)	L (MM)	SHAFT Ø MM	SILICON CARBIDE	NYLON-ALUMINIUM OXIDE	
				GRIT : 1000	GRIT : 600	
3,5	25	100	1,66	A6-02001	-	12
4,2	25	125	2,20	-	A6-02002	
4,8	25	125	2,20	-	A6-02003	
5,5	25	125	2,20	-	A6-02004	

**USER GUIDE TO
CLEAN BODY INJECTOR
AND THE NUT**



**HAND-
DRILL**

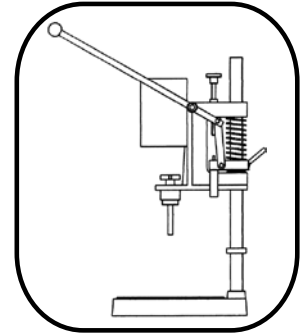

**DRILL PRESS
MACHINE**

NUT CLEANING

BRUSHES LITTLE VERSION

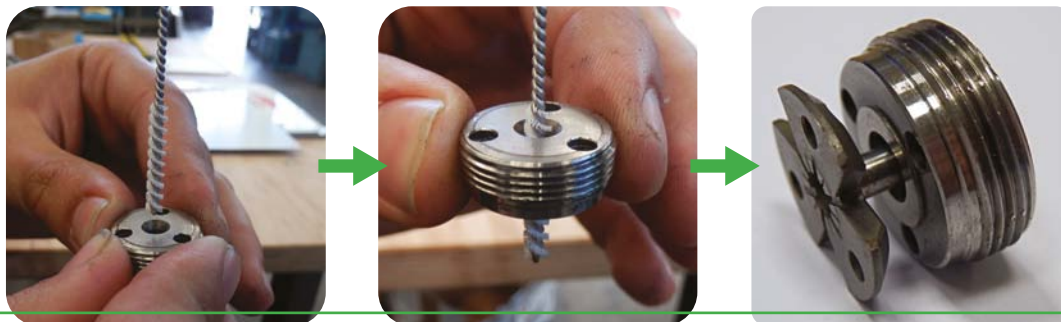

INJECTOR BODY CLEANING

BRUSHES BIG VERSION

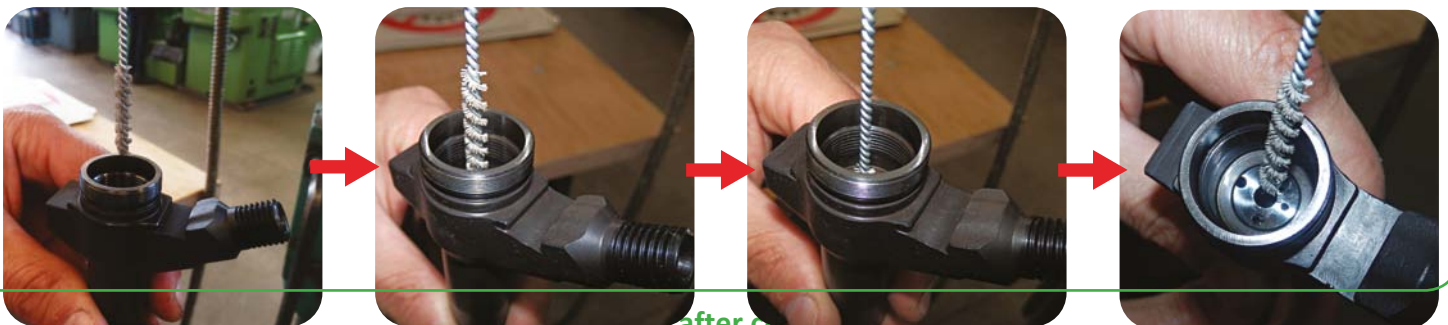

Results after cleaning

treatment performed on the injector body hole surface diameter: 7.5 mm

**Before the
treatment**

LT	4,8	MM
RA	1,00	µm
RZ	2,96	µm
RMAX	3,54	µm
RPM	1,13	µm
PC<.13>	040	CM
VER	5	µm
HOR LC	80	µm



**After
Treatment**

LT	4,8	MM
RA	0,21	µm
RZ	1,72	µm
RMAX	2,26	µm
RPM	0,60	µm
PC<.13>	202	CM
VER	5	µm
HOR LC	80	µm

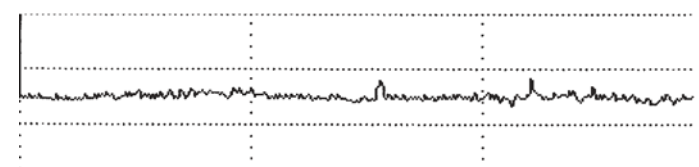



Delphi
Technologies

**Please ask for our competitive prices
on GENUINE PARTS**

New Common Rail Injectors & Nozzles

New Piezo Injectors

DRV – M Probe Sensors

Actuators for Unit Injectors

Complete New Unit Injectors & Nozzles

Mechanical Pump Repair Kits



Scania - IVECO - Volvo
Brand new UNIT INJECTORS
Repair Kits



Unit Pump Repair kits - Nozzles
Actuators
Complete VOLVO INJECTORS



Brand new INJECTORS
Piezo - Common Rail



New Unit Pumps
Repair Kits



BOSCH

Delphi
Technologies

Repair Kits & Parts For New Generation Diesel Systems

Oto Perk A.S.



*Diesel Fuel Injection
Spareparts*



www.eurodiesel.com

OTO PERK